

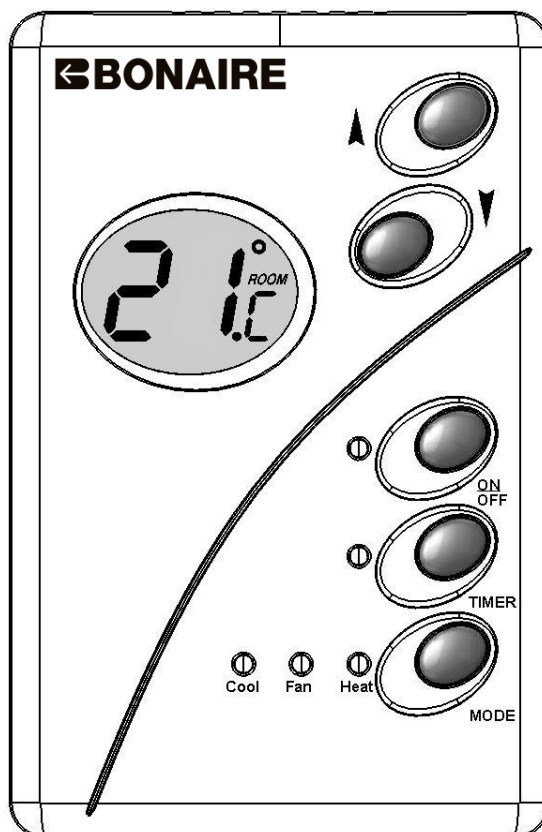

BONAIRE®

Using the
Ducted Gas Central Heating
Ducted Evaporative Air Conditioning

With your
Multi-appliance
Slimline Control



Owner's Manual

Please keep this important manual in a safe place. It is the owner's responsibility to ensure that regular maintenance is carried out on this ducted heating / cooling product. Failure to do so will void all guarantees beyond statutory and legal requirements.

www.bonaire.com.au

Contents

Introduction 4

YOUR SLIMLINE CONTROLLER 4

GENERAL INFORMATION 5

Important Installation Notice 5

Model and Serial Number 5

Warranty 5

Assembly 5

Limitations 5

Navigating the Controls 6

SLIMLINE CONTROLLER CONNECTIONS 6

FEATURES OF THE SLIMLINE CONTROLLER 7

TIMER SETUP 8

MODE CONTROL 8

ERROR REPORTING AND REMOVING ERROR 9

QUICK START - SIMPLE SLIMLINE OPERATION 9

Ducted Gas Central Heating 10

SAFETY 11

Safety & Owner Responsibility 11

Precautions 11

Features 11

Power or Gas interruption 11

OPERATING THE SLIMLINE CONTROLLER 12

Heat Mode 12

Fan Mode 13

Auto Cool Mode (Heater + Evaporative Cooler) 13

Manual Cool Mode (Heater + Evaporative Cooler) 13

HEATER MAINTENANCE 14

General Customer Maintenance 14

General Maintenance 14

Scheduled Maintenance 14

PROBLEM SOLVING 15

Ducted Evaporative Air Conditioning 16

INTRODUCTION 17

Exhaust 17

OPERATING THE SLIMLINE CONTROLLER 18

Auto Cool Mode 18

Manual Cool Mode 18

Fan Mode 18

Contents

WATER MANAGEMENT 19

Dialflo 19

Aquamiser..... 19

DUCTED EVAPORATIVE AIR CONDITIONER MAINTENANCE..... 20

General 20

Filter Pads..... 20

Water Tank 20

Water Level / Float Valve..... 20

Motor and Fan..... 21

Electrical 21

Bleed Off..... 21

Pump..... 21

Water Distribution 21

No Seasonal Maintenance..... 21

TROUBLE SHOOTING GUIDE..... 22

Appliance Warranty – Australia Only (2012) 23



Introduction

YOUR SLIMLINE CONTROLLER

This technologically advanced controller comes with Slimline control for cooling and heating plus many other setup functions.

Your Slimline Controller has been designed to operate the following products:

Heating – BONAIRE MB - 3, 4, 5 Star Ducted Gas Central Heaters.

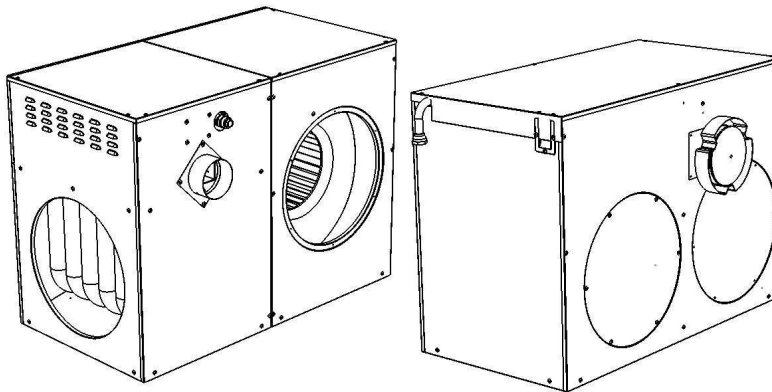

Fresh Air Conditioners – BONAIRE Ducted Evaporative Air Conditioners.

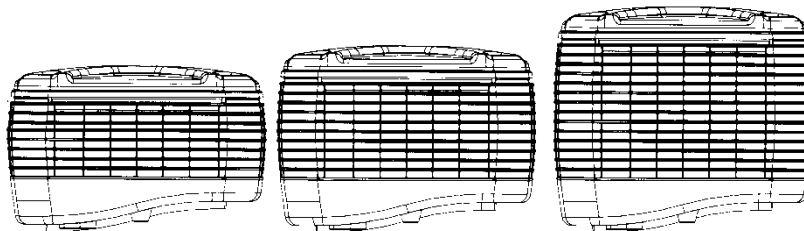

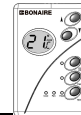

Introduction

GENERAL INFORMATION

IMPORTANT INSTALLATION NOTICE

A licensed person is required to install Climate Technologies equipment. If the equipment is not installed in accordance with the installation instructions and the governing body regulations, Climate Technologies reserves the right to refuse service on non compliant installations.

Subject to state regulations and by laws a certificate of compliance must be issued for the electrical and plumbing connections certifying that the work complies with all the relevant standards.

NOTE: *Only a licensed person will have insurance protecting their workmanship.*

MODEL AND SERIAL NUMBER

Your appliance model number, serial number and model description are located on the appliance data plate on the end of the heater or inside the cooler in the vicinity of the electronic controls. These details should also be in the warranty section of this booklet.

You will need this information, should your appliance require servicing, spare parts or just if you require additional information about this product.

WARRANTY

Warranty service work must only be carried out by Climate Technologies service division or its authorised service providers. See warranty section.

ASSEMBLY

There is no assembly required of these Ducted Heating or Cooling products. Your Dealer or installer will carry out all assembly and commissioning upon installation.

LIMITATIONS

The Slimline Controller is only to be used with MB 3, 4 & 5 star Heater Control and Evaporative Cooler Control.

The Slimline Controller will only control:

- a) One Ducted Central Heater
- b) One Evaporative Cooler
- c) A combination of one Evaporative Cooler and one Ducted Central Heater.

If the Heater is connected to the R & W input, only Heat mode will be available. Fan mode will not be available.

Text and Illustration Copyright Climate Technologies 2011

All rights reserved. No part of this document may be reproduced or transmitted in any form or by any means, electronic or mechanical, including photocopying, recording or by any information storage and retrieval system, without prior permission in writing from Climate Technologies

In the interest of continued product improvement Climate Technologies reserves the right to alter specifications without notice. E.&O.E.



Navigating the Controls

SLIMLINE CONTROLLER CONNECTIONS

There are two types of Inputs/Outputs connections on Slimline Controller.

1. Digital Communications
2. R & W Connections

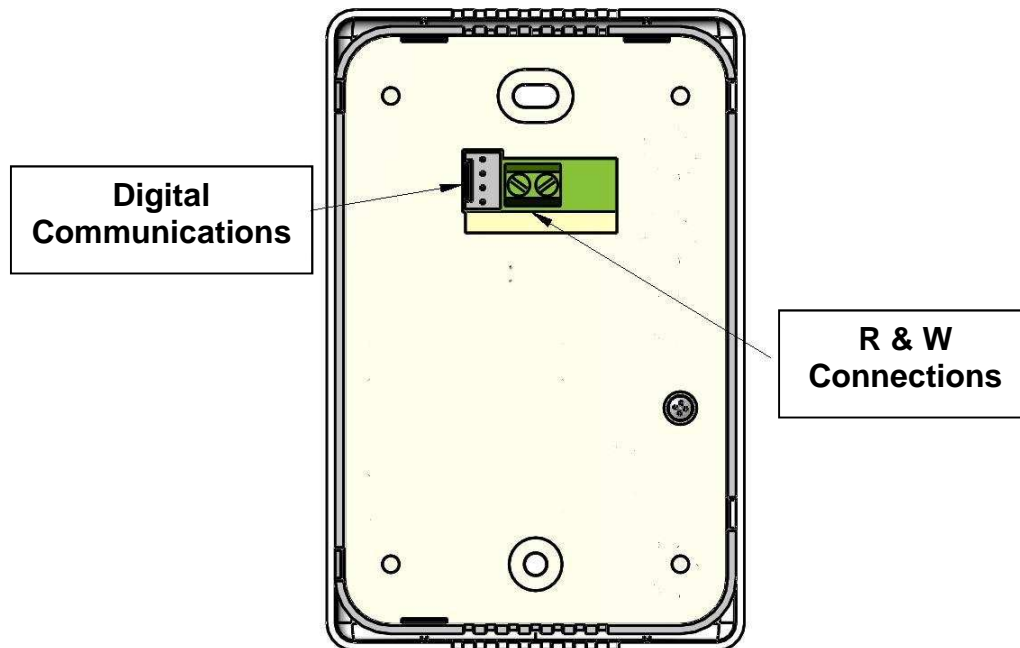

Digital Communications

Digital Communication is connected to the Slimline Controller by a 4 wire cable. The Slimline Controller will communicate with other Climate Technology products in accordance with the control system specification.

R & W Connection

This connection provides a 2 wire screw terminal for power(R) and the Heat output (W) connection. The Slimline Controller will obtain power from these connections.

IMPORTANT: These connections are only to be used if connecting to a Heater in two wire mode. This connection must not be used if the digital communications are connected.

NOTE: If the Slimline Controller is being used to operate both a heater and a cooler, then only digital communication should be used.

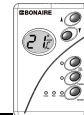

Navigating the Controls

FEATURES OF THE SLIMLINE CONTROLLER

1. **Temperature Sensor:** The Slimline Controller has an on board temperature sensor for room temperature measurement.
2. **LCD:** The LCD shows different information depending on the functions in use. The LCD usually shows only those items relevant to the appliances you have installed. It will display the room temperature (“ROOM”), set temperature (“SET”), timer count and modes of operation (**AUTO, MAN, FAN**).
3. **LEDs:** The Slimline Controller provides 5 green LEDs for status display of operation.
 - On/Off LED
 - Timer LED indicates that the timer is active.
 - Heat LED indicates heat mode.
 - Fan LED indicates fan mode.
 - Cool LED indicates cooling mode

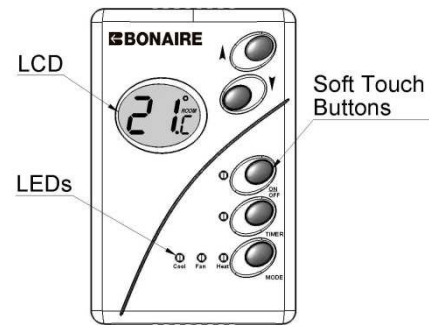

4. **5 Soft Touch Buttons:** The following explains the function of each button,
 - **ON/OFF:** Press the ON/OFF button to turn the Heating/Cooling unit ON or OFF. The ON/OFF LED is on in the “On” state and off in the “Off” state.
 - **MODE:** The Mode button will allow you to operate different modes of operation. Each press of the Mode button cycles through the available modes. The table below shows the modes presented by appliance,

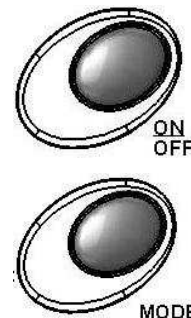

Appliances	Modes Presented
Heater	Heat, Fan
Evaporative Cooler	Auto Cool, Manual Cool, Fan
Heater with Evaporative Cooler	Heat, Auto Cool, Manual Cool, Fan

- **TIMER:** The Timer button allows the user to delay either turning off or turning on the unit. If the Timer is active, press the Timer button again to cancel the Timer function.
- **UP/DOWN:** Press Up/Down button to increase/decrease the fan, timer or temperature settings.

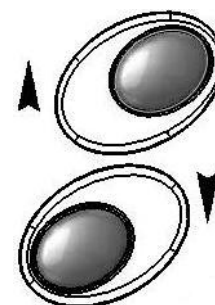
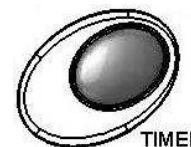



Navigating the Controls

TIMER SETUP

If the Slimline Controller is in the OFF state, the delay time displayed will represent the turn ON time. The LED of last Mode selected in the previous 'ON' state and ON/OFF LED will flash.

If the Slimline Controller is in the ON state, the delay time displayed will represent the turn OFF time.

To setup Timer,

1. Press the **TIMER** button. The Timer LED will come on and the display will show "4H" which indicates a delay time of 4 hours.
2. Press the **UP/DOWN** button to change the timer time between 1 and 24 hours. The timer function will start after five seconds. Now the unit will turn ON/OFF according to the hours you have entered.

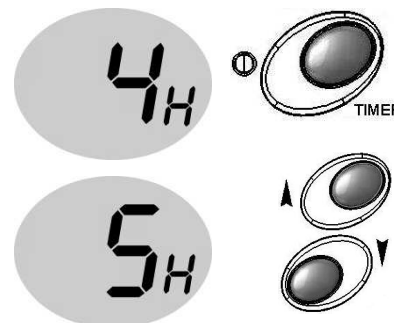

MODE CONTROL

- **Heat Mode:** In Heat Mode the Heat LED will come on and the display shows the set temperature (but reverts to room temperature after a few seconds).

Pressing the Up/down buttons will adjust the set temperature. Pressing and holding the Up/Down button for 2 seconds will result in the set temperature changing rapidly.

You can set the temperature between 10 and 35° C.

NOTE: Your heating appliance is designed to operate to 20 or 21° C. Each degree above this set level will result in a significant increase in energy consumption and running costs.

- **Auto Cool Mode:** Auto Cool Mode can be operated if an Evaporative Cooler is connected in conjunction with a central heater or an Evaporative Cooler is installed by itself. In Auto Cool Mode the Cool LED will come on and 'AUTO' will appear on the display.

In Auto Cool Mode, the display shows the comfort level and this level remains visible as long as the Slimline Controller is in Auto Cool Mode.

Press the Up/Down button to adjust the comfort level. The user can adjust the set level between 1 (cooler) and 12 (warmer).

- **Manual Cool Mode:** Manual Cool Mode can be operated if an Evaporative Cooler is connected in conjunction with a central heater or an Evaporative Cooler is installed by itself. In Manual Cool Mode the Cool LED will come on and 'MAN' will appear on the display.

Press the Up/Down button to adjust the fan speed level. The user can adjust the fan speed level between 1(Low) and 12 (High).

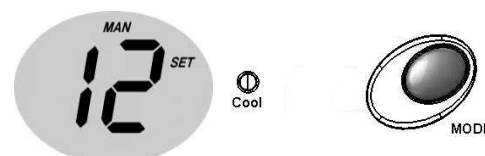
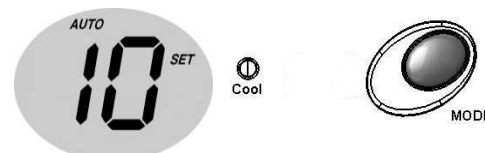
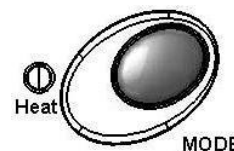



Navigating the Controls

- Fan Mode:** In Fan Mode the Fan LED will come on and 'FAN' will appear on the display. The user can adjust the Fan speed between 1(Low) and 12(High).

NOTE: Fan speed is only available if digital communication loom is installed. Please see your Authorised Bonaire Installer.

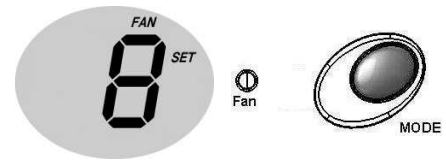

ERROR REPORTING AND REMOVING ERROR

While operating the Slimline Controller, an error will be reported by "Er" on the screen. The Slimline Controller will remain in this state until the error is removed.

To remove the error,

Press and hold the **UP/DOWN** buttons for 5 seconds. This will send the reset command to the appliance.

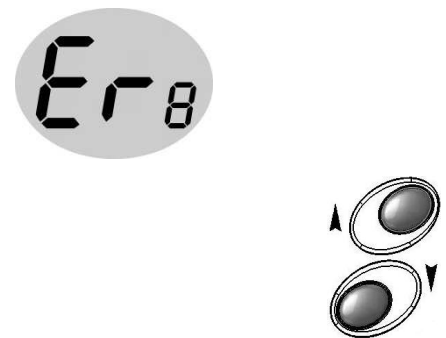

QUICK START - SIMPLE SLIMLINE OPERATION

Here's all you have to do to get going (if the installer hasn't already done it for you). Your Slimline Controller is designed to give you simple operation control over your product. Any changes made to the control settings will have a 3 second delay before the unit responds.

STEP 1 Turn the Slimline Controller ON by pressing the **ON/OFF** button.

STEP 2 Press the **MODE** button to select different modes of operation.

STEP 3 Press the **UP/DOWN** button to adjust the fan speed or the temperature setting.
(The icon(s) availability will vary according to the Appliances selected.)

STEP 4 To turn the unit off press the ON/OFF button.

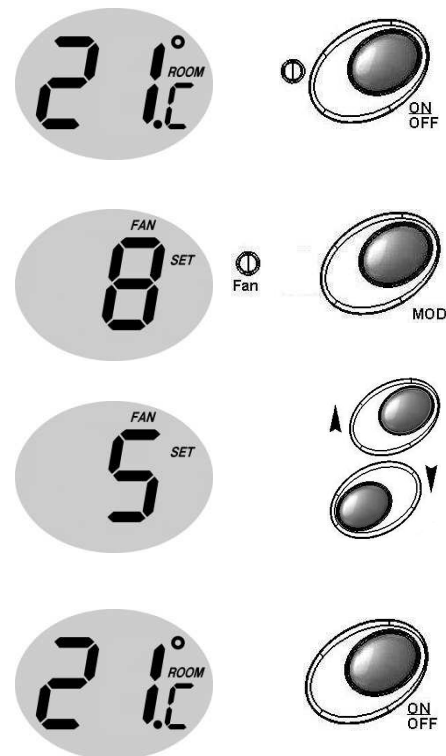

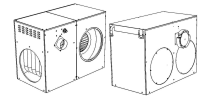

Ducted Gas Central Heating

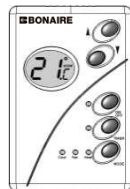
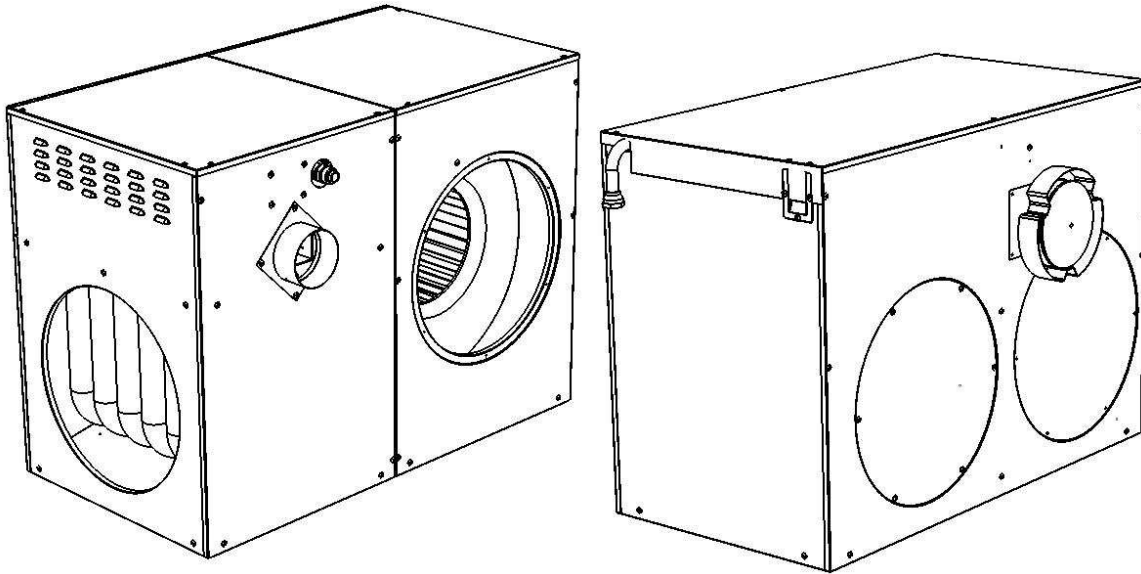

Owner's Operation and Maintenance Manual

Please keep this important manual in a safe place. It is the owner's responsibility to ensure that regular maintenance is carried out on this Ducted Gas Central Heater. Failure to do so will void all guarantees beyond statutory and legal requirements.

www.climatetechnologies.com.au

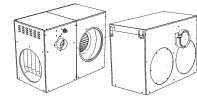

Ducted Gas Central Heating

Congratulations on purchasing this BONAIRE ducted gas central heating system, an exciting new product manufactured by Climate Technologies.

Wholly designed and manufactured in Australia, this Ducted Gas Central Heater represents an exciting new development in warm air furnace design. It embodies the latest advances in gas heating technology.

Your heater is supported by Climate Technologies, Australia's most advanced manufacturer of a complete range of climate control products.

To ensure you fully enjoy the benefits of this Ducted Gas Central Heater, please read these instructions carefully and keep them handy for future reference.

Operated and maintained in accordance with this manual, this unit will provide you with years of warm and environmentally friendly operation. Please take the time to read this manual.

SAFETY

SAFETY & OWNER RESPONSIBILITY

The manufacturer and its service providers reserve the right to refuse service unless safety and accessibility to the unit can be guaranteed. The cost of any extra equipment required to provide access to the unit for servicing is the responsibility of the owner.

This appliance is not intended for use by young children or infirm persons unless they have been adequately supervised by a responsible person to ensure that they can use the appliance safely.

Young children should be supervised to ensure that they do not play with the appliance.

PRECAUTIONS

DO NOT PLACE ARTICLES ON OR AGAINST THIS APPLIANCE.

DO NOT USE OR STORE FLAMMABLE MATERIALS NEAR THIS APPLIANCE.

DO NOT SPRAY AEROSOLS IN THE VICINITY OF THIS APPLIANCE WHILE IT IS IN OPERATION.

DO NOT PLACE ARTICLES IN FRONT OF OR OVER THE RETURN AIR GRILLE.

IF THE SUPPLY CORD IS DAMAGED, IT MUST BE REPLACED BY THE MANUFACTURER, ITS SERVICE AGENT OR SIMILARLY QUALIFIED PERSONS IN ORDER TO AVOID A HAZARD.

FEATURES

Your Ducted Gas Central Heater has all the safety devices to ensure safe operation. These devices conform to the standards set out by the Australian Gas Association.

POWER OR GAS INTERRUPTION

Should there be an interruption to the power supply during the heating operation the controls will automatically turn off the gas.

When the power is restored, the control will be in the OFF position and therefore will not resume operation until turned ON.

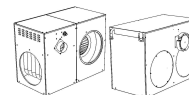

Ducted Gas Central Heating

OPERATING THE SLIMLINE CONTROLLER

To operate your Slimline Controller simply press the ON / OFF button. The unit will then display the default or last used settings and will be ready to operate. Any changes made to the Slimline Control settings will have a 3 second delay before the unit responds.

If an Evaporative cooler is connected in conjunction with a central heater, you may have to toggle through the modes to select the heating functions.

HEAT MODE

STEP 1 Turn the Slimline Controller ON by pressing the **ON/OFF** button.

NOTE: Your Slimline Controller is designed to automatically detect the appliances you have installed. Controller options not required for your connected appliances will be hidden and not displayed, therefore some menu items shown in this instruction may not appear.



STEP 2 Press the **MODE** button until Heat LED turns ON.



STEP 3 Press the **UP/ DOWN** buttons to increase or decrease the set temperature.

NOTE: The controller measures the room temperature using a thermostat inside its housing. When the ROOM TEMP is cooler than the SET TEMP the heater will come on after approximately a 30 second ignition process. The controller will run the heater until it measures temperature a little above your SET TEMP. The unit will turn off until the temperature falls a little below SET TEMP before restarting.



STEP 4 Press the **ON/OFF** button to turn the heater OFF.

OPERATION: The Slimline Controller remembers your SET TEMP setting and uses it the next time you turn it ON. The operation of the 4 and 5 star heaters is as follows:

- If at start up the room temperature is below the set temperature, the central heater will start up at high fan speed and high gas rate quickly bringing your house up to temperature.
- As the room temperature gets closer to the SET TEMP the central heater will reduce the room air fan and the gas rate to the burner.
- When the thermostat reaches the SET TEMP the central heater will shut down. When the temperature has dropped below SET TEMP the unit will restart.
- For economical operation, set a low SET TEMP during the day when you are active. Switch the controller OFF when asleep and ON again when awake.

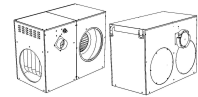

Ducted Gas Central Heating

FAN MODE

In Fan mode, the fan in the heater can be used to circulate the room air without running the heating.

NOTE: Fan speed is only available if digital communication loom is installed. Please see your Authorised Bonaire Installer.

To operate the Fan Mode:

- STEP 1** Turn the Slimline Controller ON by pressing the **ON/OFF** button.
- STEP 2** Press the **MODE** button until '**FAN**' appears on the display and the Fan LED will turn on.
(Note the room air fan is only circulating room air, there will be no fresh air content.)
- STEP 3** Press the **UP/DOWN** buttons to increase or decrease the level of the fan speed 1 (low) to 12 (high).

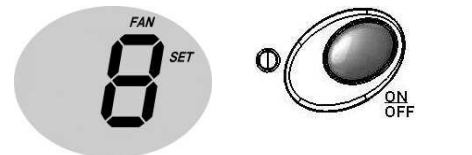
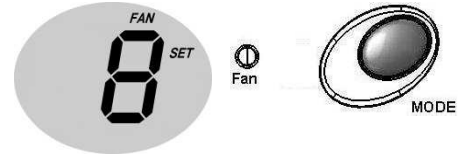

AUTO COOL MODE (HEATER + EVAPORATIVE COOLER)

Auto Cool Mode can be operated if the Evaporative Cooler is connected in conjunction with a central heater.

To operate the Auto Cool Mode,

- STEP 1** Turn the Slimline Controller ON by pressing the **ON / OFF** button.
- STEP 2** Press the **MODE** button until '**AUTO**' appears on the display and the Cool LED turns on.
- STEP 3** Press the **Up/Down** button to adjust the comfort level.

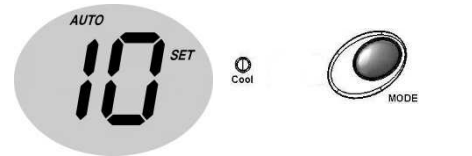

MANUAL COOL MODE (HEATER + EVAPORATIVE COOLER)

Manual Cool Mode can be operated if the Evaporative Cooler is connected in conjunction with a central heater.

To operate Manual Cool Mode,

- STEP 1** Turn the Slimline Controller ON by pressing the **ON / OFF** button.
- STEP 2** Press the **MODE** button until '**MAN**' appears on the display and the Cool LED turns on.
- STEP 3** Press the **Up/Down** button to adjust the fan speed.

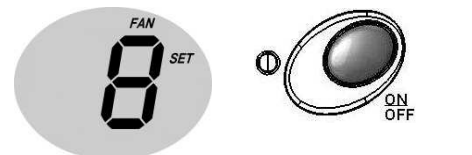

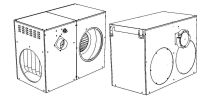

Ducted Gas Central Heating

HEATER MAINTENANCE

GENERAL CUSTOMER MAINTENANCE

Return Air Grille Filter.

If your heating system has a filter in the return air grille, it is extremely important it is cleaned every 3 – 4 weeks during the operating period to ensure correct operation of the heating unit. Failure to do so may cause your heater to stop because of over temperature and cause an unnecessary service call not covered by warranty.

GENERAL MAINTENANCE

All service work and general maintenance should only be carried out by a licensed qualified and trained service technician.

Electrical

WARNING: Before commencing any maintenance work on your unit, isolate the power at the supply (Fuse Box).

No general maintenance is required to the electrical system.

A Licensed Electrician only should carry out electrical connections and maintenance.

Flue

The flue and cowl assembly should be clean and free of obstructions.

SCHEDULED MAINTENANCE

NOTE: *It is essential that your central heater be maintained in accordance with Climate Technologies requirements. Failure to do so will affect the life of the product and reduce the level of efficiency which may also affect your warranty.*

Your Ducted Gas Central Heater should be serviced at least every 2 years to ensure trouble free operation, and as recommend by state gas authorities.

1. To ensure that your heater continues to *operate* at peak efficiency it is recommended that it be periodically serviced by a qualified service technician (for your nearest Climate Technologies service office refer to Service section of this document).
2. Fan blades, motors, ignition systems and burners should be checked. Heater cabinet and immediate surroundings should be kept clean and clear.

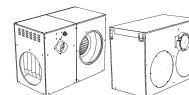

Ducted Gas Central Heating

PROBLEM SOLVING

Central Heater will not operate!

	Question	Y/N	Solution
1.	Has the unit been run since installation?	Yes	Refer to question 4
		No	Check the unit is turned on at the power point and the gas cock is turned on. Call the installer to commission the unit.
2.	Is the unit installed in a new home?	Yes	Refer to question 3
		No	Refer to question 4
3.	Has the installer run the unit?	Yes	Refer to question 4
		No	Check the unit is turned on at the power point and the gas cock is turned on. Call the installer to commission the unit.
4.	Is the SET TEMP greater than the ROOM TEMP?	Yes	Turn the control off then on to reset unit. If the unit still does not start call for service.
		No	Increase the SET TEMP so the thermostat calls for heat.
5.	Has there been a known power surge?	Yes	Reset the unit. This can be done by: Turn the control OFF then ON. The unit should resume operation.
		No	Unit should operate normally. If not a service call will be required.

THIS TROUBLE SHOOTING GUIDE IS A REFERENCE ONLY.

FOR SERVICE OR WARRANTY REQUIREMENTS PLEASE REFER TO
THE WARRANTY SECTION OF THIS BOOK

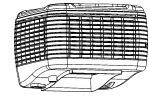

Ducted Evaporative Air Conditioning

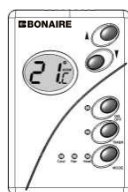
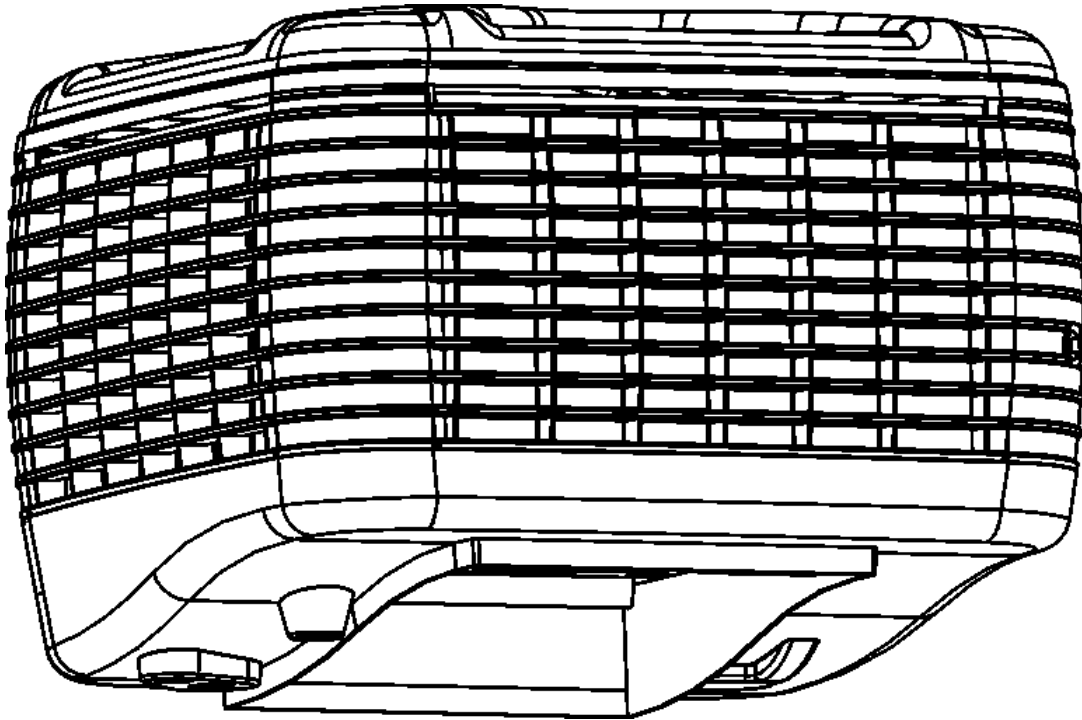

Owners Operating and Maintenance

Please keep this important manual in a safe place. It is the owner's responsibility to ensure that regular maintenance is carried out on this Evaporative Air Conditioner. Failure to do so will void all guarantees beyond statutory and legal requirements.

www.climatetechnologies.com.au

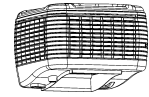

Ducted Evaporative Air Conditioning

INTRODUCTION

Your ducted evaporative air conditioner is engineered to meet the rigors of our harsh Australian environment. Operated and maintained in accordance with this manual, it will provide you with years of cool and environmentally friendly operation. Please take the time to read this manual.

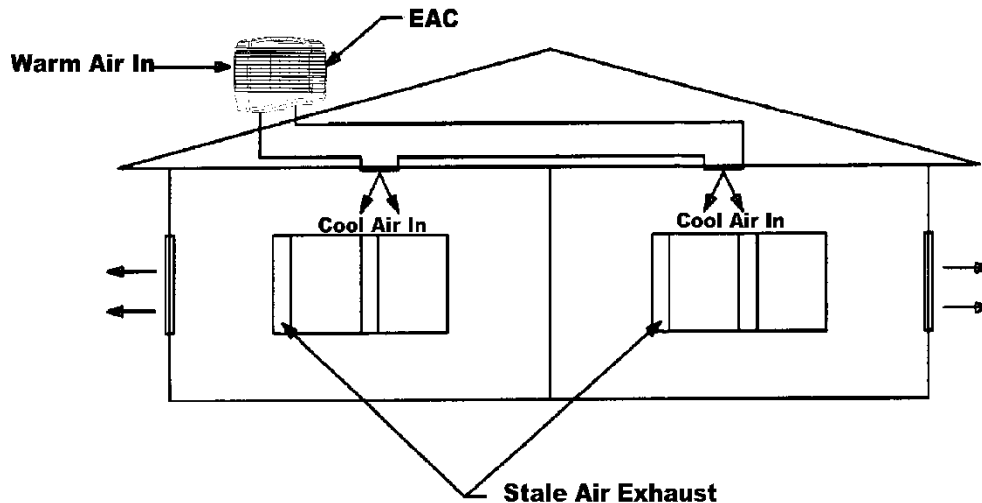

The principal of your unit is to introduce fresh air, which is washed through the filter pads to provide cool fresh air. The air is relieved taking with it any heat loading on the home.

EXHAUST

It is essential for successful operation of evaporative air-conditioning that there be sufficient relief openings in the area to be ventilated. Open doors and windows will usually provide this.

The minimum relief opening should be as per the table guide set out below. It is recommended that ceiling vents or exhaust fans be used where there is any doubt about there being sufficient relief area available. Ceiling exhaust fans or ceiling vents should have a capacity equivalent to that of the air conditioner.

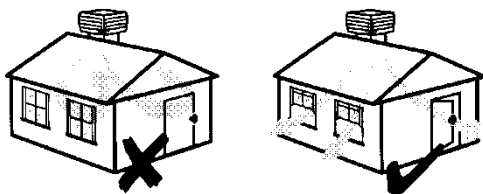

Vent Area for Doors and Windows

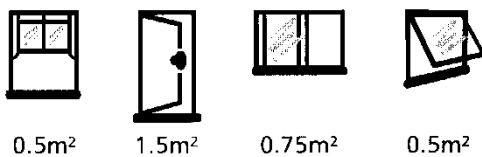

MODEL	MINIMUM RELIEF AREA
Small	0.85 m ²
Medium	1.19 m ² to 1.48 m ²
Large	2.02 m ²

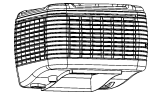

Ducted Evaporative Air Conditioning

OPERATING THE SLIMLINE CONTROLLER

To operate your Slimline Controller, simply press the ON/OFF button. The unit will then display the default or last used settings and will be ready to operate. Any changes made to the Slimline Controller settings will have a 3 second delay before the unit responds.

If the Evaporative cooler is connected in conjunction with a central heater you may have to toggle through the modes to select the Evaporative cooling functions.

AUTO COOL MODE

To operate Auto Cool Mode,

- STEP 1** Turn the Slimline Controller ON by pressing the **ON / OFF** button.
- STEP 2** Press the **MODE** button until the '**AUTO**' icon appears on the display and the Cool LED turns on.
- STEP 3** Press the **Up/Down** button to increase or decrease the comfort level 1 (Cooler) to 12 (Warmer).

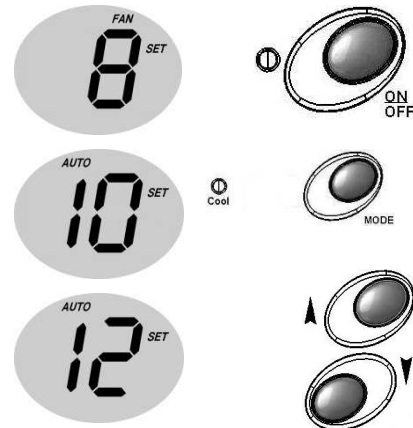

MANUAL COOL MODE

To operate Manual Cool Mode,

- STEP 1** Turn the Slimline Controller ON by pressing the **ON / OFF** button.
- STEP 2** Press the **MODE** button until the '**MAN**' icon appears on the display and the Cool LED turns on.
- STEP 3** Press the **Up/Down** button to increase or decrease the fan speed 1 (low) to 12 (high).

Note For Pump Only operation, when in manual mode, press the arrow down button to reach "0". PO (for pump only) will be displayed on the handset.

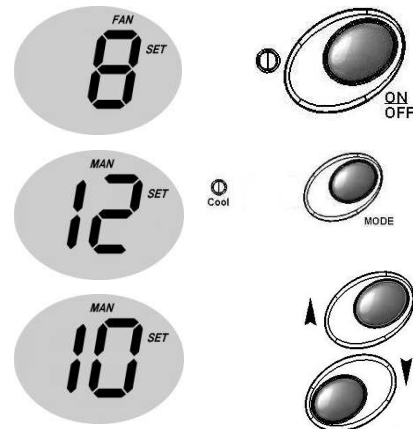

FAN MODE

Fan Mode only delivers fresh air (with the pump not operating). To operate Fan Mode,

- STEP 1** Turn the Slimline Controller ON by pressing the **ON / OFF** button.
- STEP 2** Press the **MODE** button until the '**FAN**' icon appears on the display and the Fan LED turns ON.
- STEP 3** Press the **UP/DOWN** button to increase or decrease the fan speed.

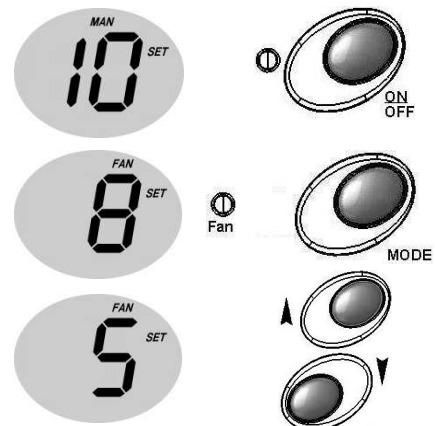

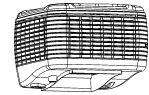

Ducted Evaporative Air Conditioning

WATER MANAGEMENT

DIALFLO

BLEED OFF

All evaporative air conditioners need some water bleed-off to prevent build-up of mineral deposits in the system. The correct setting of the bleed rate will ultimately govern the life of the unit.

With normal town water supply, in good water quality areas, bleed rate should be adjusted so that the discharge is not less than 10 litres per hour subject to unit size. Increased water hardness may require a higher bleed rate and increased maintenance.

Setting the BLEED OFF Rate

To set the bleed rate, locate the patented DIALFLO externally on one of the corner posts. Rotate the BLEED knob clockwise for more flow and anti clockwise.

NOTE: Hold the distribution knob (Filler) while setting the bleed rate as the distribution flow rate may go out of adjustment.

It is recommended that the bleed water is plumbed away to waste in accordance with local and state plumbing requirements.

Setting the Water Distribution Flow Rate

To set the water distribution flow rate to the filter pads, rotate filter knob anti-clockwise for more water and clockwise for less water. To control bleed-off rate rotate bleed dial clockwise for more water and anti-clockwise for less water.

NOTE: Hold the bleed knob while setting the distribution rate as the bleed rate may go out of adjustment.

AQUAMISER

The Aquamiser operates as a dumping valve. Whenever the fill valve is de-energised or energised, the dump motor is driven open or closed.

When the Aquamiser is fitted, bleed off may not be required in some areas, however it is the responsibility of the dealer / installer to correctly determine for your location.

Drainage from the Aquamiser needs also to be plumbed away in accordance with local and state plumbing requirements. Its Climate Technologies recommendation that the drain from the Aquamiser is plumbed to waste.

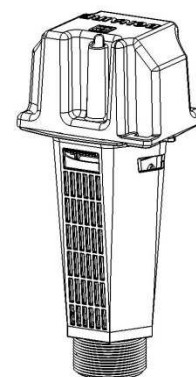
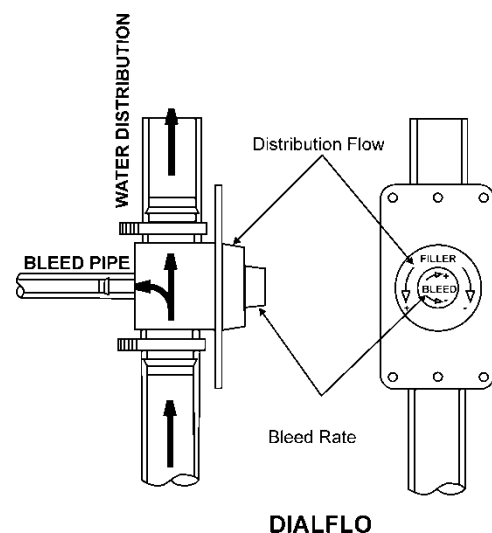
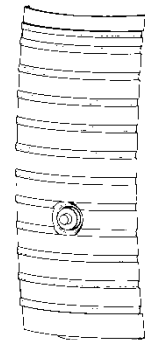

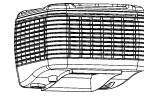

Ducted Evaporative Air Conditioning

DUCTED EVAPORATIVE AIR CONDITIONER MAINTENANCE

GENERAL

All Ducted Evaporative Air Conditioners require some general maintenance to ensure continued cooling efficiency and a long life. Maintenance is carried out at the beginning and end of summer to start up and close down your unit.

We recommend that all maintenance work be undertaken by our fully trained and accredited Service Technicians or an authorised Climate Technologies Service Provider.

The frequency of general maintenance will depend on local operating conditions such as water quality, air borne dust and pollen.

It is essential that your evaporative air conditioner is maintained in accordance with this manual. Failure to do so will affect the life of the product, reduce the level of efficiency and may void warranty.

For service Australia wide refer to the details on the service section of this manual.

NOTE: *The manufacturer and its agents reserve the right to refuse service unless safety and accessibility to the unit can be guaranteed. The cost of any extra equipment required to provide access to the unit for servicing is the responsibility of the owner.*

SAFETY: *Prior to commencing any maintenance isolate the unit at the power source. Ensure the roof is safe to access, your ladder is securely positioned and use suitable safety equipment.*

FILTER PADS

Visually check CELDEK pads for damage or blockage. Hose down pads from both sides to remove any build up of salts, dust and pollen. In dusty areas more regular cleaning is recommended. Check the water distributor, making sure it is clear and free from blockage. Failure to do so may lead to uneven water distribution and therefore less efficient operation.

WATER TANK

It is important to keep the water tank clean and free from sediment and algae growth. To clean the tank, use a soft brush or similar. Wipe all surfaces in the tank while it is full of water (DO NOT FORGET THE PUMP STRAINER). Turn off the water inlet to the unit (an Isolation Valve should be fitted to the water inlet before the Float Valve). Drain the tank. It may be necessary to repeat this procedure if the tank is very dirty.

SAFETY: *Wet roofs are dangerous – Take Care When Draining Tank.*

WATER LEVEL / FLOAT VALVE

The water level should be set at nominal 65-70mm before filter pads are saturated. After run off from operating filters the level should be 25 – 30mm from the top of the Aquamiser overflow. The float valve is a mechanical type and is factory set. If the valve is leaking, the seal may require cleaning or replacing. Turn off the water. Remove the split pin and then float arm. Remove piston and clean or turn seal. Flush system and replace piston, float arm and split pin.

NOTE: *Water supply line to float valve must be flushed before connecting.*

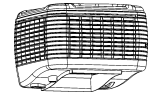

Ducted Evaporative Air Conditioning

MOTOR AND FAN

Check that the fan spins freely and that there is no build up on the blades.

ELECTRICAL

No general maintenance is required to the electrical system.

If the supply cord is damaged, it must be replaced by a special cord or assembly available from the manufacturer or it's service agent.

A Qualified Electrician should only carry out electrical connections and maintenance.

BLEED OFF

The bleed rate should be checked to ensure it is adequate and that there is no build up of mineral deposits in or on your air conditioner. White deposits indicate high mineral content and the Bleed Rate should be increased. If it is at maximum and the deposits are still forming, then more regular maintenance is required.

PUMP

Check the pump spins freely and that the strainer is clean.

WATER DISTRIBUTION

Check the water distribution system for blockage. Check the delivery tube for kinks or holes. Check that the clamps are secure and in place.

NO SEASONAL MAINTENANCE

Your unit has been supplied with an Aquamiser. As long as the Aquamiser has been fitted, there is no need for regular checking of the system during the operating (summer) period. This however does not remove the responsibility of the customer to have the unit service on an annual basis to check the unit function and to ensure the unit is clean and free from any mineral deposit build up.

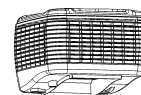

Ducted Evaporative Air Conditioning

TROUBLE SHOOTING GUIDE

PROBLEM	PROBABLE CAUSE	REMEDY
Unit fails to start	A Black – out b Tripped Circuit Breaker c Blown Fuse d Electrical Fault	a Wait b Reset c Replace d Call Climate Technologies Service Provider
Pump fails to start	a Pump Seized b Pump Burnt Out	a Isolate power and then take off top of pump and try to free it. Some lubricant may help. b Call Climate Technologies Service Provider
Water leaking	a Float Valve Leaking b Drain from Celdek Pads	a Check adjustment or replace seal b Normal Operation
Water Droplets in air stream	a Loose Delivery Tube b Break in tubing c Pump Delivers Excessive Water to Pads	a Check and tighten b Replace as necessary c Adjust the Dialflo to reduce the flow
Excessive humidity	a Inadequate Relief b Outside humidity high	a Provide more open area to relieve stale air b Turn pump off.
Inadequate Cooling	a Dirty Filters b Dry Filters c Dialflo not set correctly	a Clean / Replace b Check water delivery system. Adjust if necessary. c Adjust Dialflo so that the pads have even saturation.
Unpleasant Odor	a Unit located near odor source b New Celdek filter smell	a Remove source b Smell will disappear after a period of operation (Approximately 48 hours or use).
Rapid formation of white deposits on pads	High Mineral Content	Bleed off should be set at maximum. More regular maintenance may be required.

THIS TROUBLE SHOOTING GUIDE IS A REFERENCE ONLY.
 FOR SERVICE OR WARRANTY REQUIREMENTS PLEASE REFER
 TO THE LAST PAGE OF THESE INSTRUCTION

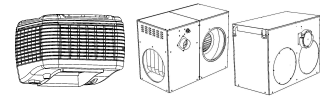

Appliance Warranty – Australia Only (2012)

Standard Warranty

IMPORTANT:

The warranties contained in this document (“**the warranty**”) are provided voluntarily by Climate Technologies (as manufacturer) to you (as consumer) in relation to your purchase of a product from Climate Technologies (“**the product**”) and are in addition to any rights you may have under the Australian Consumer Law or other applicable legislation. Please read this warranty in full and complete the Dealer / Product information on page 26. KEEP this with your original purchase documents for any claim you may wish to make under this warranty.

WARRANTY PROCEDURES:

Firstly refer to your owner’s manual to ensure that you have followed the correct operating procedures of your product, and refer to the trouble shooting guide to assist solving any problems you may have.

1. Read this warranty statement carefully before you request warranty service as items related to installation are not covered by this appliance warranty.
2. A proof of product purchase must be provided by you to Climate Technologies when exercising any rights under this or any statutory or other warranty, as evidence that the appliance is within the relevant manufacturer’s warranty periods (which are outlined in the tables on pages 28 and 29 of this warranty).
3. This warranty is only for Climate Technologies products and associated original controls for Climate Technologies manufactured product.
4. Only an authorised Climate Technologies service provider may carry out a warranty service.
5. To the extent permitted by law, any statutory warranty that applies to goods sold by Climate Technologies is valid for 12 months from the date of purchase and any additional warranties provided to you are at the sole discretion of Climate Technologies.

Climate Technologies provides the following Manufacturers warranty on new products in addition to all implied warranties and other statutory rights which you may have under the Australian Consumer Law and similar State & Territory Laws, subject to the following terms and conditions.

Terms and Conditions:

This warranty is subject to, and conditional upon, the following terms and conditions:

- Subject to the exclusions noted, Climate Technologies warrant the product for the period as prescribed in the table on pages 28 and 29 of this warranty to be free from inherent defects in materials and workmanship for functional and structural components.
- This warranty is only valid if the product is operated and maintained in accordance with the manufacturer’s instructions
- The appliance must not be modified or changed in any way.
- Your proof of purchase MUST be produced before free service will be provided.
- Travelling time and mileage are included in the service within 30km of either your authorised Climate Technologies dealer or service provider’s premises. Customers in areas other than the above are responsible for any travelling time and mileage required to carry out warranty repairs.

Standard Warranty effective May 1 2012

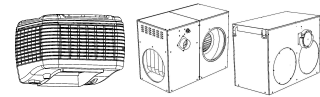

Appliance Warranty – Australia Only (2012)

- The product purchased and subject to this warranty must be installed by a qualified person in the manner prescribed by local & statutory regulations and to the manufacturer's specifications.
- Service within the terms of this warranty will be recognised where Climate Technologies are satisfied that the product or part was supplied within the relevant time limits (prescribed on pages 28 and 29 of this warranty). You are required to keep, and provide Climate Technologies with, proof of purchase and Dealer / Installer information in relation to the product the subject of your warranty claim.
- Product fitness for purpose and overall system design / sizing is solely the responsibility of the dealer / installer and, to the extent permitted by law, Climate Technologies takes no responsibility for, and this warranty is not valid to cover, any loss that is suffered by you as a result directly or indirectly of purchasing a product that is not fit for the purpose you intended or is in any other way inadequate for this purpose. This includes but is not limited to heat load calculations, air flow, system balancing, humidity, water quality etc.
- The product must be installed in an easily and safe accessible area for service. Where appliances are installed in areas not easily and safely accessible, costs will be borne by you for any access equipment required to be utilised by a representative or agent of Climate Technologies, in the event that maintenance of such an appliance is required.

DIY installation Warranty

If the product has been installed DIY or other than by an authorised person, a supply part only warranty will apply. Only parts will be supplied free of charge and then only on the return of the faulty part. In the event that a warranty claim is made to which this provision applies, you will be responsible for all labour charges incurred for the part to be fitted by a qualified person, such person to be appointed by Climate Technologies or one of their authorised dealers. The labour warranty as prescribed in the tables on pages 28 and 29 of this warranty are void where the product in question has not been installed by an authorised person.

Remote Location Warranty

If the product has been installed outside of the Climate Technologies service network, a supply part only warranty will apply. Only parts will be supplied free of charge where the product the subject of the warranty claim was installed further than 30km from the nearest Climate Technologies authorised dealer or service providers premises, and then only on the return of the faulty part. In the event that a warranty claim is made to which this provision applies, you will be responsible for all labour charges incurred for the part to be fitted by a qualified person, such a person to be appointed by Climate Technologies or one of their authorised dealers. The labour warranty prescribed in the tables on pages 28 and 29 of this warranty are void where the product in question has been installed in an area outside the Climate Technologies network (as prescribed above).

Effect of this Warranty

If you, as the purchaser of a product sold by Climate Technologies, comply with your obligations under this warranty document and a defect exists in a product you have purchased from Climate Technologies, Climate Technologies will, at its sole discretion, repair or replace the defective product (or part of it).

Any remedial work undertaken by Climate Technologies or one of its approved representatives or agents will be conducted at Climate Technologies sole expense, subject to the terms and conditions and exclusions contained in this warranty.

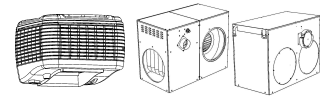

Appliance Warranty – Australia Only (2012)

Climate Technologies will not reimburse you for any expense you have incurred in applying for a remedy under this warranty, including, but not limited to, any telephone calls or postage expenses incurred.

Exclusions to warranty

The following are not covered under this warranty, and Climate Technologies takes no responsibility for the replacement or repair of:

- Consumable items which are subject to wear and tear such as filter pads, drive belts, batteries and bearings;
- Any third party components used as part of the installation such as grille filters, ducting, fittings, zone motors and pipe work. These items are warranted from your place of purchase;
- Damage caused by elements such as wind, rain, lightning, floods etc along with power spiking and brownouts which are not considered by Climate Technologies in their sole discretion (acting reasonably) to be defective material or workmanship;
- Damage caused by outside elements such as pests, animals, pets and vermin or similar that may cause damage to the product;
- Harsh environmental situations such as salt air that may cause cabinet damage and/or rusting.

Please be aware that to the extent permitted by law, the manufacturer does not accept liability or any claims for damage to building contents, carpet, walls, ceilings, foundations or any other consequential loss incurred by you or any other person as a result of the purchase or installation of a product from Climate Technologies or by any other means, whether such loss was incurred directly or indirectly. For the avoidance of doubt, damage resulting from power spikes, incorrect operation, incorrect installation, and incorrect maintenance is also not covered under this warranty and such damage is not the responsibility of Climate Technologies.

All warranties contained in this warranty are given for the exclusive benefit of you as the purchaser of a Climate Technologies product and are not transferable and cannot be sold, assigned, gifted or transferred in any other way.

Events where warranty may be void

In the event that any of the following occur, this warranty may be void, and Climate Technologies reserves the right to refuse to repair or replace a defective product in accordance with a term of this warranty, where:

- There is no certificate of compliance for plumbing, electrical or refrigeration as required by State & Territory Laws;
- The product operates defectively due to failure of electricity, gas, water or refrigerant gas supplied;
- The defect is caused by neglect, incorrect application, abuse or by accidental damage to the product;
- An unauthorised person has attempted to repair the appliance;
- A situation arises which is referenced in the trouble-shooting guide (because you as the purchaser are required to remedy such a situation yourself).

Please note that a charge will be made for work done or a service call made where the Climate Technologies authorised representative or agent determines at his/her sole discretion (acting reasonably) that there is nothing wrong with the product in question.

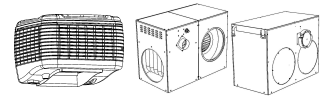

Appliance Warranty – Australia Only (2012)

Australian Consumer Law disclaimer

Our goods come with guarantees that cannot be excluded under the Australian Consumer Law. You are entitled to a replacement or refund for a major failure and for compensation for any other reasonably foreseeable loss or damage. You are also entitled to have the goods repaired or replaced if the goods fail to be of acceptable quality and the failure does not amount to a major failure.

PROOF OF PURCHASE

It is important that the name of the Dealer or Retailer from whom you purchased your product and the name of the installer are recorded on this page. The installer is responsible for the correct installation, start up and demonstrating the operation of this product. The Dealer or retailer is also responsible for issuing the relevant Certificates of Compliance (these may differ from state to state).

Please attach your proof of purchase here. Your receipt, along with the terms of this document is your warranty and will be required to validate any claim made under the terms of this warranty.

Dealer/Retailer:	
Dealer Address:	
Dealer Phone Number:	
Unit Model Number:	
Serial No:	
Date installed:	
Installed by:	
Date Commissioned:	
Commissioned by:	Signature:

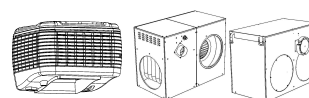

Appliance Warranty – Australia Only (2012)

HOW TO EXERCISE YOUR RIGHTS UNDER THIS WARRANTY

Only qualified service personnel should conduct any service work carried out on the Climate Technologies product. It is important that periodical service is carried out on your product to ensure you will receive the efficiency benefits the product provides.

If you acquire a product or service from Climate Technologies which is defective, please contact your nearest Climate Technologies representative on the phone numbers or emails listed below, or contact your nearest Climate Technologies Service Provider. Please note you will be required to show proof of your purchase, and comply with the terms and conditions and all other applicable provisions of this warranty in order for Climate Technologies to proceed with the remedial action prescribed under this warranty.

For Service, ring the telephone numbers below or send an email to the addresses below:

Fyshwick	ACT	(02) 6147 3490	nsw.service@climtech.com.au
Albury	NSW	(02) 6062 2990	nsw.service@climtech.com.au
Leeton	NSW	(02) 5924 1190	nsw.service@climtech.com.au
Silverwater	NSW	(02) 9735 7090	nsw.service@climtech.com.au
Wagga	NSW	(02) 5963 2939	nsw.service@climtech.com.au
Willawong	QLD	(07) 3712 4390	nsw.service@climtech.com.au
Salisbury	SA	(08) 8307 5230	service.sa@climtech.com.au
Bendigo	VIC	(03) 4411 1940	vic.service@climtech.com.au
Dandenong	VIC	(03) 8795 2456	vic.service@climtech.com.au
Shepparton	VIC	(03) 5835 6998	vic.service@climtech.com.au
Forrestfield	WA	(08) 9454 1000	service.wa@climtech.com.au

The business address of Climate Technologies is:

26 Nylex Avenue, Salisbury, SA, 5108

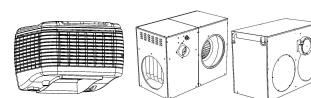

Appliance Warranty – Australia Only (2012)

PERIODS OF WARRANTY – Years By Product And Application:

Ducted Gas Heating – 3 star internal

Unit Components	RESIDENTIAL		COMMERCIAL	
	Parts	Labour	Parts	Labour
Heat Exchanger	10	3	2	2
Burner	10	3	2	2
**All other components	3	3	1	1

** Excluding consumables and third party supplied components, which are not covered by this warranty.

Ducted Gas Heating – 3 star external, 4 star and 5 star

Unit Components	RESIDENTIAL		COMMERCIAL	
	Parts	Labour	Parts	Labour
Heat Exchanger	10	5	2	2
Burner	10	5	2	2
**All other components	5	5	1	1

** Excluding consumables and third party supplied components, which are not covered by this warranty.

Ducted Reverse Cycle Air Conditioning

Unit Components	RESIDENTIAL		COMMERCIAL	
	Parts	Labour	Parts	Labour
Compressor	5	5	2	2
**All other components	5	5	2	2

** Excluding consumables and third party supplied components, which are not covered by this warranty.

Dual Cycle Refrigerated Air Conditioning

Unit Components	RESIDENTIAL		COMMERCIAL	
	Parts	Labour	Parts	Labour
Compressor	5	5	2	2
** All other components	5	5	2	2

** Excluding consumables and third party supplied components, which are not covered by this warranty.

Ducted Evaporative Air Conditioning - Domestic

Unit Components	RESIDENTIAL		COMMERCIAL	
	Parts	Labour	Parts	Labour
Corrosion on Cabinet	25	5	2	2
Structural Guarantee	10	5	2	2
** All other components	5	5	1	1

** Excluding consumables and third party supplied components, which are not covered by this warranty.

Ducted Evaporative Air Conditioning –Commercial Industrial

Unit Components	Parts	Labour
Corrosion on Cabinet	2	2
Structural Guarantee	2	2
** All other components	2	2

** Excluding consumables and third party supplied components, which are not covered by this warranty.

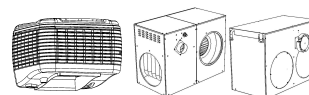

Appliance Warranty – Australia Only (2012)

Space Heater - Wall Furnace

Unit Components	RESIDENTIAL		COMMERCIAL	
	Parts	Labour	Parts	Labour
Heat Exchanger	10	2	2	2
Burner	10	2	2	2
All other components	2	2	1	1

Space Heater - Heritage

Unit Components	RESIDENTIAL		COMMERCIAL	
	Parts	Labour	Parts	Labour
Heat Exchanger & Burner	10	1	1	1
Blower (Fan)	2	2	1	1
All other components	1	1	1	1

Warranty on Replacement Parts

Parts replaced under warranty are warranted for the balance of the original warranty period.

Aged New Product Warranties

The terms of this Standard Warranty apply where the product is purchased and installed by the original purchaser within 3 years of the manufacturing date. To the extent permitted by law where, for whatever reason, a product is not installed within a period of 3 years of the manufacturing date of that product then the following warranty conditions will apply:

- For a product that is installed more than 3 years but less than 5 years from the date of its manufacture, the statutory warranties under the Australian Consumer Law or any other applicable legislation will apply and any voluntary warranty originally supplied by Climate Technologies under the terms of this warranty will be reduced by 1 year.
- To the extent permitted by law, for a product that is installed more than 5 years from the date of its manufacture, the statutory warranties under the Australian Consumer Law or any other applicable legislation will apply to electrically functioning components only. No other components will be covered by either this warranty or any warranty provided under the Australian Consumer Law or any other applicable legislation.
- For the avoidance of doubt, where a product is installed more than 5 years from the date of manufacture, no voluntary warranty originally supplied will be valid and Climate Technologies will not be responsible for the repair or replacement of the product, unless required to be pursuant to the Australian Consumer Law or similar applicable legislation.



“Excelling today for a better tomorrow”

Manufactured by
Climate Technologies
ABN 13 001 418 042

26 Nylex Avenue
Salisbury, SA 5108
Australia

www.bonaire.com.au