

TOSHIBA

Leading Innovation >>>

AIR CONDITIONER (SPLIT TYPE)

Owner's Manual



Indoor Unit

Model name:

Concealed Duct High Static Pressure Type

RAV-SM2242DT-E

RAV-SM2802DT-E

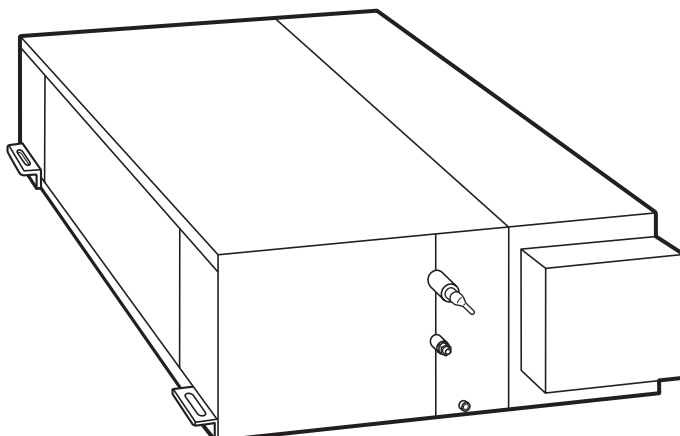

Owner's Manual
Air conditioner (Split type)

English

Original instruction

ADOPTION OF NEW REFRIGERANT

This Air Conditioner uses R410A an environmentally friendly refrigerant.

This appliance is not intended for use by person (including children) with reduced physical, sensory or mental capabilities, or lack of experience and knowledge, unless they have been given supervision or instruction concerning use of the appliance by a person responsible for their safety.

Contents

1 PRECAUTIONS FOR SAFETY.....	4
2 PART NAMES.....	7
3 WIRED REMOTE CONTROLLER.....	8
4 CORRECT USAGE.....	11
5 TIMER OPERATION.....	13
6 POWER SAVING MODE.....	14
7 ADVANCED SETTINGS.....	15
8 ENERGY SAVING RECOMMENDATIONS.....	16
9 MAINTENANCE.....	17
10 AIR CONDITIONER OPERATIONS AND PERFORMANCE.....	19
11 INSTALLATION.....	20
12 TROUBLESHOOTING.....	21
13 SPECIFICATIONS.....	22

Thank you for purchasing this Toshiba air conditioner.

Please read carefully through these instructions that contain important information which complies with the “Machinery” Directive (Directive 2006/42/EC), and ensure that you understand them.

Some of the details provided in these instructions differ from the Owner's Manual supplied with your product, and the instructions provided here take precedence.

After reading these instructions, be sure to keep them in a safe place together with the Owner's Manual and Installation Manual supplied with your product.

Generic Denomination: Air Conditioner















Definition of Qualified Installer or Qualified Service Person

The air conditioner must be installed, maintained, repaired and removed by a qualified installer or qualified service person. When any of these jobs is to be done, ask a qualified installer or qualified service person to do them for you.

A qualified installer or qualified service person is an agent who has the qualifications and knowledge described in the table below.

Agent	Qualifications and knowledge which the agent must have
<ul style="list-style-type: none"> • Qualified installer 	<ul style="list-style-type: none"> • The qualified installer is a person who installs, maintains, relocates and removes the air conditioners made by Toshiba Carrier Corporation. He or she has been trained to install, maintain, relocate and remove the air conditioners made by Toshiba Carrier Corporation or, alternatively, he or she has been instructed in such operations by an individual or individuals who have been trained and is thus thoroughly acquainted with the knowledge related to these operations. • The qualified installer who is allowed to do the electrical work involved in installation, relocation and removal has the qualifications pertaining to this electrical work as stipulated by the local laws and regulations, and he or she is a person who has been trained in matters relating to electrical work on the air conditioners made by Toshiba Carrier Corporation or, alternatively, he or she has been instructed in such matters by an individual or individuals who have been trained and is thus thoroughly acquainted with the knowledge related to this work. • The qualified installer who is allowed to do the refrigerant handling and piping work involved in installation, relocation and removal has the qualifications pertaining to this refrigerant handling and piping work as stipulated by the local laws and regulations, and he or she is a person who has been trained in matters relating to refrigerant handling and piping work on the air conditioners made by Toshiba Carrier Corporation or, alternatively, he or she has been instructed in such matters by an individual or individuals who have been trained and is thus thoroughly acquainted with the knowledge related to this work. • The qualified installer who is allowed to work at heights has been trained in matters relating to working at heights with the air conditioners made by Toshiba Carrier Corporation or, alternatively, he or she has been instructed in such matters by an individual or individuals who have been trained and is thus thoroughly acquainted with the knowledge related to this work.
<ul style="list-style-type: none"> • Qualified service person 	<ul style="list-style-type: none"> • The qualified service person is a person who installs, repairs, maintains, relocates and removes the air conditioners made by Toshiba Carrier Corporation. He or she has been trained to install, repair, maintain, relocate and remove the air conditioners made by Toshiba Carrier Corporation or, alternatively, he or she has been instructed in such operations by an individual or individuals who have been trained and is thus thoroughly acquainted with the knowledge related to these operations. • The qualified service person who is allowed to do the electrical work involved in installation, repair, relocation and removal has the qualifications pertaining to this electrical work as stipulated by the local laws and regulations, and he or she is a person who has been trained in matters relating to electrical work on the air conditioners made by Toshiba Carrier Corporation or, alternatively, he or she has been instructed in such matters by an individual or individuals who have been trained and is thus thoroughly acquainted with the knowledge related to this work. • The qualified service person who is allowed to do the refrigerant handling and piping work involved in installation, repair, relocation and removal has the qualifications pertaining to this refrigerant handling and piping work as stipulated by the local laws and regulations, and he or she is a person who has been trained in matters relating to refrigerant handling and piping work on the air conditioners made by Toshiba Carrier Corporation or, alternatively, he or she has been instructed in such matters by an individual or individuals who have been trained and is thus thoroughly acquainted with the knowledge related to this work. • The qualified service person who is allowed to work at heights has been trained in matters relating to working at heights with the air conditioners made by Toshiba Carrier Corporation or, alternatively, he or she has been instructed in such matters by an individual or individuals who have been trained and is thus thoroughly acquainted with the knowledge related to this work.

■ Warning Indications on the Air Conditioner Unit

Warning indication	Description		
<table border="1"> <tr> <td data-bbox="165 387 300 607">  </td> <td data-bbox="304 387 660 607"> <p style="text-align: center;">WARNING</p> <p>ELECTRICAL SHOCK HAZARD Disconnect all remote electric power supplies before servicing.</p> </td> </tr> </table>		<p style="text-align: center;">WARNING</p> <p>ELECTRICAL SHOCK HAZARD Disconnect all remote electric power supplies before servicing.</p>	<p>WARNING</p> <p>ELECTRICAL SHOCK HAZARD Disconnect all remote electric power supplies before servicing.</p>
	<p style="text-align: center;">WARNING</p> <p>ELECTRICAL SHOCK HAZARD Disconnect all remote electric power supplies before servicing.</p>		
<table border="1"> <tr> <td data-bbox="165 669 300 889">  </td> <td data-bbox="304 669 660 889"> <p style="text-align: center;">WARNING</p> <p>Moving parts. Do not operate unit with grille removed. Stop the unit before the servicing.</p> </td> </tr> </table>		<p style="text-align: center;">WARNING</p> <p>Moving parts. Do not operate unit with grille removed. Stop the unit before the servicing.</p>	<p>WARNING</p> <p>Moving parts. Do not operate unit with grille removed. Stop the unit before the servicing.</p>
	<p style="text-align: center;">WARNING</p> <p>Moving parts. Do not operate unit with grille removed. Stop the unit before the servicing.</p>		
<table border="1"> <tr> <td data-bbox="165 952 300 1171">  </td> <td data-bbox="304 952 660 1171"> <p style="text-align: center;">CAUTION</p> <p>High temperature parts. You might get burned when removing this panel.</p> </td> </tr> </table>		<p style="text-align: center;">CAUTION</p> <p>High temperature parts. You might get burned when removing this panel.</p>	<p>CAUTION</p> <p>High temperature parts. You might get burned when removing this panel.</p>
	<p style="text-align: center;">CAUTION</p> <p>High temperature parts. You might get burned when removing this panel.</p>		
<table border="1"> <tr> <td data-bbox="165 1234 300 1453">  </td> <td data-bbox="304 1234 660 1453"> <p style="text-align: center;">CAUTION</p> <p>Do not touch the aluminum fins of the unit. Doing so may result in injury.</p> </td> </tr> </table>		<p style="text-align: center;">CAUTION</p> <p>Do not touch the aluminum fins of the unit. Doing so may result in injury.</p>	<p>CAUTION</p> <p>Do not touch the aluminum fins of the unit. Doing so may result in injury.</p>
	<p style="text-align: center;">CAUTION</p> <p>Do not touch the aluminum fins of the unit. Doing so may result in injury.</p>		
<table border="1"> <tr> <td data-bbox="165 1516 300 1736">  </td> <td data-bbox="304 1516 660 1736"> <p style="text-align: center;">CAUTION</p> <p>BURST HAZARD Open the service valves before the operation, otherwise there might be the burst.</p> </td> </tr> </table>		<p style="text-align: center;">CAUTION</p> <p>BURST HAZARD Open the service valves before the operation, otherwise there might be the burst.</p>	<p>CAUTION</p> <p>BURST HAZARD Open the service valves before the operation, otherwise there might be the burst.</p>
	<p style="text-align: center;">CAUTION</p> <p>BURST HAZARD Open the service valves before the operation, otherwise there might be the burst.</p>		

1 PRECAUTIONS FOR SAFETY

WARNING

General

- Carefully read Owner's Manual before starting the air conditioner. There are many important things to keep in mind for daily operation.

Transportation and storage

- When transporting the air conditioner, wear shoes with additional protective toe caps.
- When transporting the air conditioner, do not take hold of the bands around the packing carton. You may injure yourself if the bands should break.
- When stacking the packing cartons for storage or transportation, heed the precautions written on the packing cartons. Failure to heed the precautions may cause the stack to collapse.

Installation

- Only a qualified installer(*1) or qualified service person(*1) is allowed to carry out the electrical work of the air conditioner. Under no circumstances must this work be done by an unqualified individual since failure to carry out the work properly may result in electric shocks and/or electrical leaks.
- After the installation work has been completed, have the installer explain about the circuit breaker positions. In the event that trouble has occurred in the air conditioner, set the circuit breaker to the OFF position, and contact a service person.
- If you install the unit in a small room, take appropriate measures to prevent the refrigerant from exceeding the limit concentration even if it leaks. Consult the dealer from whom you purchased the air conditioner when you implement the measures. Accumulation of highly concentrated refrigerant may cause an oxygen deficiency accident.
- Do not install the air conditioner in a location that may be subject to a risk of expire to a combustible gas. If a combustible gas leaks and becomes concentrated around the unit, a fire may occur.

Operation

- Before opening the intake grille of the indoor unit or service panel of the outdoor unit, set the circuit breaker to the OFF position. Failure to set the circuit breaker to the OFF position may result in electric shocks through contact with the interior parts. Only a qualified installer(*1) or qualified service person(*1) is allowed to remove the intake grille of the indoor unit or service panel of the outdoor unit and do the work required.
- Inside the air conditioner are high-voltage areas and rotating parts. Due to the danger of electric shocks or of your fingers or physical objects becoming trapped in the rotating parts, do not remove the intake grille of the indoor unit or service panel of the outdoor unit. When work involving the removal of these parts is required, contact a qualified installer or a qualified service person.
- Do not move or repair any unit by yourself. Since there is high voltage inside the unit, you may get electric shock when removing the cover and main unit.
- Use of a stand more than 50 cm high to clean the filter of the indoor unit or to carry out other such jobs constitutes working at heights. Due to the danger of falling off the stand and injuring yourself while working at heights, this kind of work should not be done by unqualified individuals. When this kind of work must be carried out, do not do it yourself but ask a qualified installer or a qualified service person to do it for you.
- Do not touch the aluminum fin of the outdoor unit. You may injure yourself if you do so. If the fin must be touched, do not touch it yourself but contact a qualified installer or a qualified service person.
- Do not climb onto or place objects on top of the outdoor unit. You may fall or the objects may fall off of the outdoor unit and result in injury.
- Do not place any combustion appliance in a place where it is directly exposed to the wind of air conditioner, otherwise it may cause imperfect combustion.
- When the air conditioner is operated with a combustion appliance in the same place, be careful of ventilation to let fresh air enter the room. Poor ventilation causes oxygen shortage.
- When the air conditioner is used in a closed room, be careful of sufficient ventilation of the room. Poor ventilation causes oxygen shortage.

Repairs

- When you have noticed that some kind of trouble (such as when an error display has appeared, there is a smell of burning, abnormal sounds are heard, the air conditioner fails to cool or heat or water is leaking) has occurred in the air conditioner, do not touch the air conditioner yourself but set the circuit breaker to the OFF position, and contact a qualified service person. Take steps to ensure that the power will not be turned on (by marking "out of service" near the circuit breaker, for instance) until qualified service person arrives. Continuing to use the air conditioner in the trouble status may cause mechanical problems to escalate or result in electric shocks, etc.
- If you have discovered that the fan grille is damaged, do not approach the outdoor unit but set the circuit breaker to the OFF position, and contact a qualified service person to have the repairs done. Do not set the circuit breaker to the ON position until the repairs are completed.
- If you have discovered that there is a danger of the indoor unit's falling, do not approach the indoor unit but set the circuit breaker to the OFF position, and contact a qualified installer or a qualified service person to refit the unit. Do not set the circuit breaker to the ON position until the unit has been refitted.
- If you have discovered that there is a danger of the outdoor unit's toppling over, do not approach the outdoor unit but set the circuit breaker to the OFF position, and contact a qualified installer or a qualified service person to have the improvements or refitting done. Do not set the circuit breaker to the ON position until the improvements or refitting is completed.

Relocation

- When the air conditioner is to be relocated, do not relocate it yourself but contact a qualified installer or a qualified service person. Failure to relocate the air conditioner properly may result in electric shocks and/or a fire.

(*1) Refer to the "Definition of Qualified Installer or Qualified Service Person."

 **CAUTION**

TO DISCONNECT THE APPLIANCE FROM THE MAINS SUPPLY

- This appliance must be connected to the mains by means of a switch with a contact separation of at least **3 mm**.
- **The installation fuse 25A must be used for the power supply line of this air conditioner.**

CAUTIONS ABOUT INSTALLATION (Be sure to confirm the following cautions.)

- Certainly lay the drain hose for perfect draining.
Bad drainage may cause flooding in the house and getting furniture wet.
- Make sure to connect the air conditioner to an exclusive power supply of the rated voltage, otherwise the unit may break down or cause a fire.

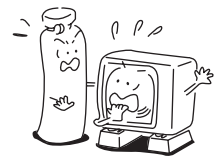



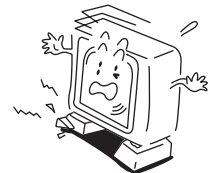



**CAUTIONS ABOUT OPERATION**

- Do not use this air conditioner for special purpose such as preserving food, precision instruments, art objects, breeding animals, car, vessel, etc.
- Do not touch any switches with wet finger, otherwise you may get an electric shock.
- If the air conditioner will not be used for a considerably long time, turn off the main switch or the circuit breaker, for safety.
- To make the air conditioner operate in its original performance, operate it within the range of the operating temperature specified in the instructions.
Otherwise it may cause a malfunction, or water leak from the unit.
- Prevent any liquid from falling into the remote controller.
Do not spill juice, water or any kind of liquid.



Information on the Transportation, Handling and Storage of the Carton

Examples of indication on the carton

Symbol	Description	Symbol	Description
	Keep dry	 DO NOT DROP	Do not drop
 FRAGILE	Fragile	 DO NOT LAY DOWN	Do not lay down
 11 cartons	Stacking height (12 cartons can be stacked in this case)	 DO NOT WALK ON THIS CARTON	Do not walk on this carton
	This side up		Do not step
	Handle with care		

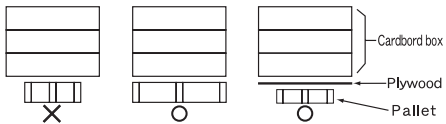
Other cautions	Description
 <div style="border: 1px solid black; padding: 5px;"> <p>Caution</p> <p>Injury possibility. Don't handle with packing band, or may get injured in case of broken band.</p> </div>	<p>CAUTION</p> <p>Injury possibility. Don't handle with packing band, or may get injured in case of broken band.</p>
<div style="border: 1px solid black; padding: 5px;"> <p>Stacking notice.</p> <p>In case that cardboard boxes protrude out of pallet when stacking, lay a 10mm thick plywood over the pallet.</p>  </div>	<p>Stacking notice.</p> <p>In case that cardboard boxes protrude out of pallet when stacking. Lay a 10 mm thick plywood over the pallet.</p>

2 PART NAMES

■ Indoor unit

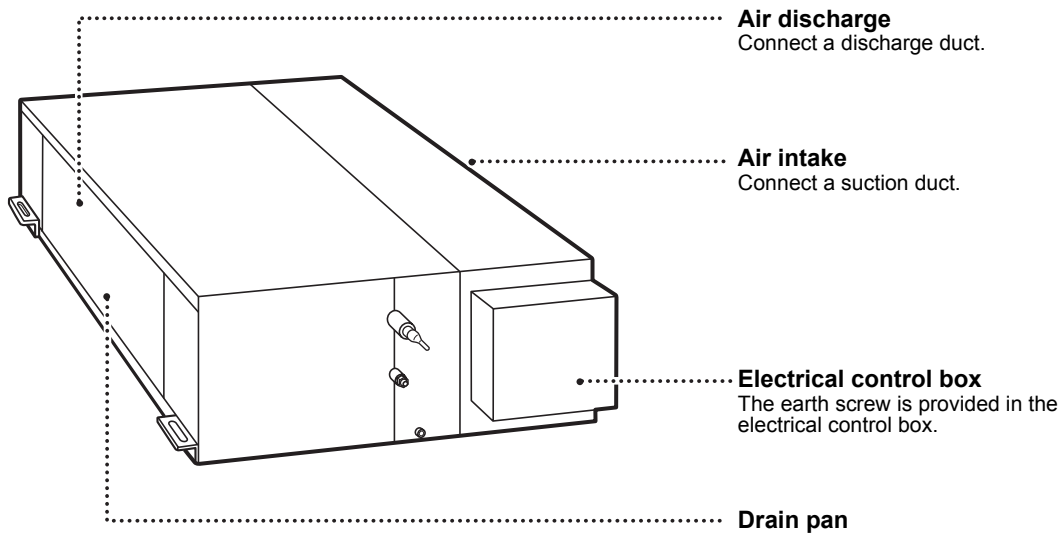

Separate sold part

Remote controller

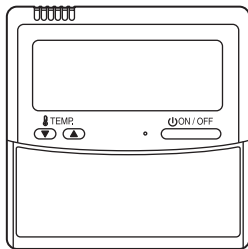

■ Outdoor unit

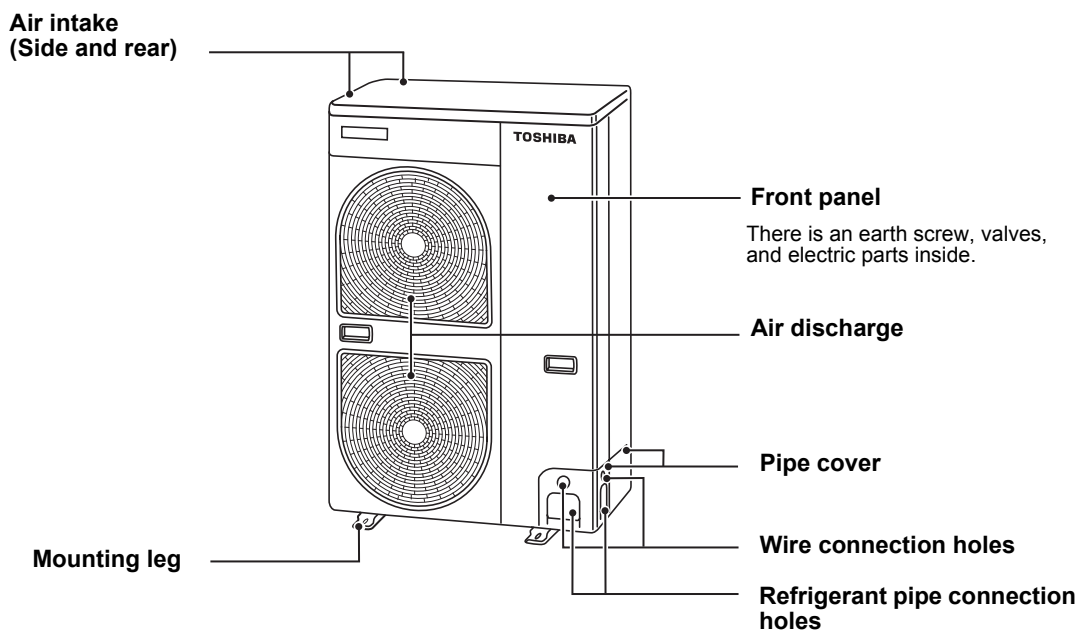

3 WIRED REMOTE CONTROLLER

This remote controller can control the operation of up to 8 indoor units.

■ Display section

In the display illustration below all the icons are shown. When the unit is in operation, only relevant icons will be displayed.

- When turning on the leak breaker at the first time, **SETTING** flashes on the display part of the remote controller.
- While this icon is flashing, the model is being automatically confirmed. Wait till **SETTING** icon has disappeared to use the remote controller.

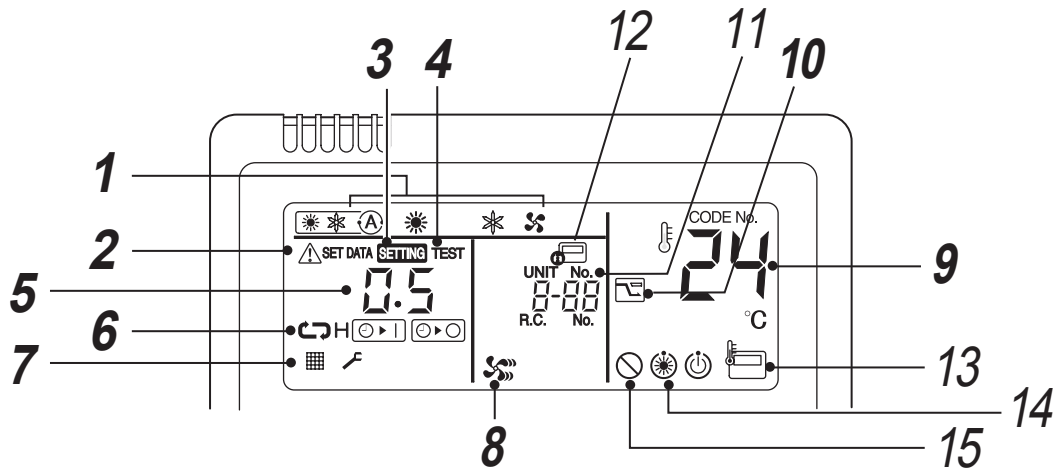
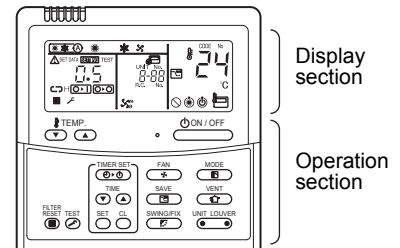

1 Operation mode

The selected operation mode is displayed.

2 Error display

Displayed while the protective device works or a error occurs.

3 SETTING display

Displayed during setup of the timer or other settings.

4 TEST run display

Displayed during a test run.

5 Timer display

When an error occurs, error code is displayed.

6 Timer mode display

The selected timer mode is displayed.

7 Filter display

Reminder to clean the air filter.

8 Fan speed display

Fan speed is not adjustable. It is fixed to High.

(HIGH)

9 Set temperature display

The selected set temperature is displayed.

10 Power saving mode display

Limits compressor speed (capacity) to save energy.

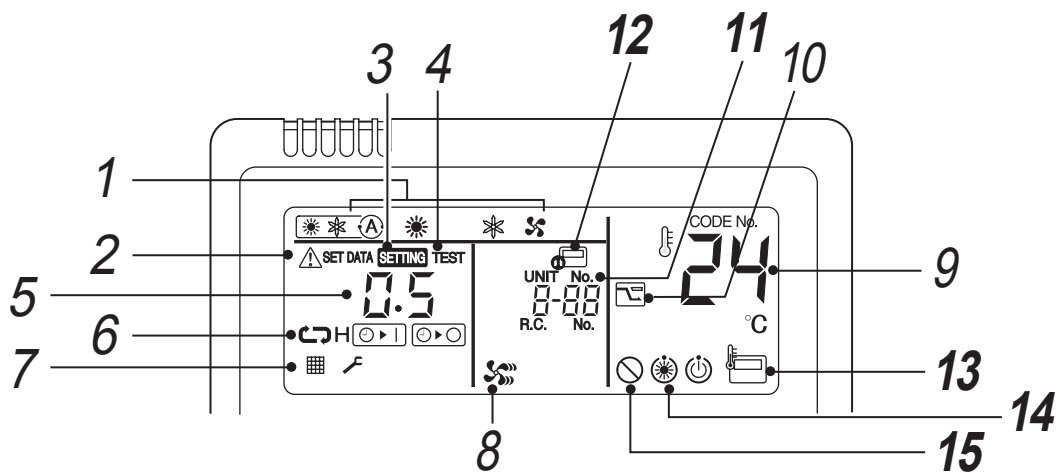

11 UNIT No. display

Displays the number of the indoor unit selected.
Also displays error code of indoor and outdoor units.

12 Central control display

Displayed when the air conditioner is used under the central control in combination with a central control remote controller.

In case the remote controller is disabled by the central control system,  flashes.
The button operation is not accepted.

Even when you push ON/OFF, MODE, or TEMP. button, and the button operation is not accepted.
(Settings made by the remote controller vary with the central control mode. For details, refer to the Owner's Manual of the central control remote controller.)

13 Remote controller sensor display

Displayed while the sensor of the remote controller is used.

14 Pre-heat display

Displayed when the heating mode is energized or defrost cycle is initiated.
While this icon is displayed, the indoor fan stops.

15 No function display

Displayed when the function requested is not available on that model.

■ Operation section

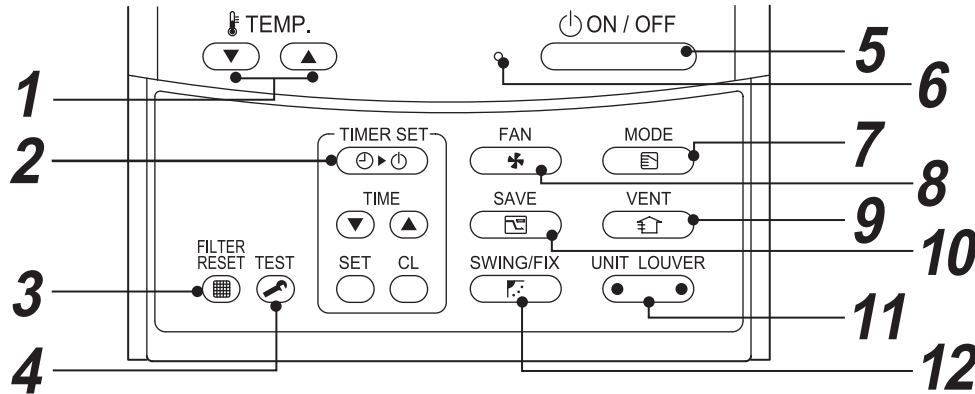

Push each button to select a desired operation.

- The control saves commands in memory and after the initial setting, there is no need for any additional settings unless changes are desired. The air conditioner can be operated by pushing the  button.



1 button (Temperature set button)

Adjusts the set point.

Select the desired set point by pushing  TEMP. .

2 button (Timer set button)

Use to setup the timer.

3 button (Filter reset button)

Resets “” icon after cleaning filter.

4 button (Test button)

Use only for service.

(During normal operation, do not use this button.)

5 button

When the button is pushed, the operation starts, and it stops by pushing the button again.

When the operation has stopped, the operation lamp and all the displays disappear.

6 Operation lamp

Green light illuminates when unit is on.

Although it flashes when operating the protection device or an error occurs.

7 button (Operation mode button)

Selects desired operation mode.

8 button (Fan speed button)

Fan speed is not adjustable.

It is fixed to High.

9 button (Ventilation button)

Use when a power ventilation kit (locally procured) is connected.

- If “” is displayed on the remote controller when this button is pushed no vent kit connected.

10 button (Power save operation)

Use to initiate power saving mode.

11 button (Unit/Louver select button)

Selects a unit number (left) and louver number (right).

UNIT:

Selects an indoor unit when multiple indoor units are controlled with one remote controller.

LOUVER:

No Function.

12 button (Swing/Louver direction button)

No Function.

OPTION :

Remote controller sensor

Usually the temperature sensor of the indoor unit senses the temperature. The temperature on the surrounding of the remote controller can also be sensed.

For details, contact the dealer from which you have purchased the air conditioner.

4 CORRECT USAGE

- When you use the air conditioner for the first time or when you change the setting, follow the steps below. Settings are saved in memory and are displayed anytime the unit is turned on by pushing the  button.

■ Preparation

Turn on the main power switch and/or the leakage breaker.

- When the power supply is turned on, a partition line is displayed on the display part of the remote controller.
- After the power supply is turned on, the remote controller does not accept an operation for approx. 1 minute, but it is not a failure.

REQUIREMENT

- While using the air conditioner, operate it only with  button without turning off the main power switch and the leakage breaker.
- When you re-power the air conditioner after it has not been used for a long period, turn on the leakage breaker at least 12 hours before starting the air conditioner. (This is required to turn on the compressor case heater for warming in order to prevent overload on the compressor when activating the outdoor unit.)

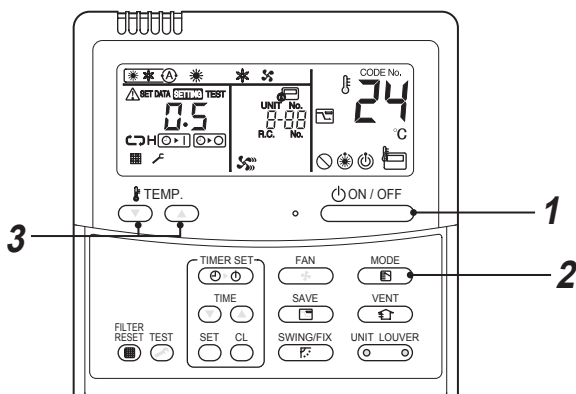

Stop

Push  button.

The operation lamp goes off, and the operation stops.

NOTE

Auto Changeover

- When in Auto Mode, the unit selects the operating mode (cooling, heating or fan only) based on the user selected set point temperature.
- If the Auto mode is uncomfortable, you can select the desired conditions manually.

Cooling

- If there is a demand for cooling, unit will start approximately 1 minute after mode is selected.

Heating

- If there is a demand for heating, unit will start approximately 3 to 5 minutes after the mode is selected.
- After the heating operation has stopped, fan may continue to run for approx. 30 seconds.
- When the room temperature reaches the set temperature, the outdoor unit stops and the indoor unit will carry on fan operation. During defrost operation, the fan stops so that cool air is not discharged. (“” Pre-heat is displayed.)

When restarting the operation after stop

- When attempting to restart the unit immediately after it was stopped, the unit can not start for approx. 3 minutes this is to protect the compressor.

Start

1 Push button.

The operation lamp illuminates, and the operation starts.

2 Select an operation mode with the “” button.

One push of the button, and the display changes in the order shown below.

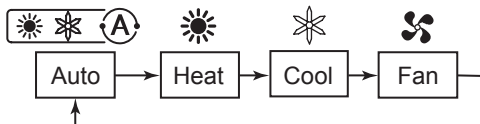

3 Select a desired set point by pushing the “TEMP. ” or “TEMP. ” button.



■ 8°C OPERATION (For object pre-heating)

(Available for Super Digital Inverter outdoor units)

The air conditioner can control the heating temperature to about 8°C in the heating mode.

The 8°C heating operation requires settings with the wired remote controller. Ask the installer or dealer for the settings according to the installation manual of the indoor unit.

Start

- 1 Set the displayed temperature to 18°C in the heating mode by pushing TEMP.  button.
- 2 Set the displayed temperature to 8°C by pushing TEMP.  button for at least four seconds.



Stop

- 1 Set the displayed temperature to 18°C by pushing TEMP.  button.
 - The air conditioner returns to the normal HEAT mode. Select a desired temperature and operation mode.

NOTE

- The discharged air temperature is lower than that in the normal heating operation.
- The room temperature may not be heated evenly depending on the remote controller installation location.
- The room temperature may not reach 8°C depending on the room size or the installation conditions.

The 8°C heating operation is cancelled in the following cases.

 - When operation is stopped with  button
 - When another operation mode is selected with  button
 - When temperature setting or operation mode is changed or operation is started/stopped by the wireless remote controller or the central control remote controller.
- If one or more models other than the 4-way air discharge cassette type (4 series), slim duct, Concealed Duct High Static Pressure are connected in the same control group, the 8°C heating operation is not available.
- When you use this operation mode, observe proper operating hours and we recommend that you ask service staff for periodic maintenance of the air conditioner.

5 TIMER OPERATION

- Three timer modes are available: (Setting of up to 168 hours is enabled.)
 - Off timer : The unit stops when the set time is reached.
 - Repeat Off timer : The unit stops daily when the set time is reached.
 - On timer : The unit starts when the set time is reached.

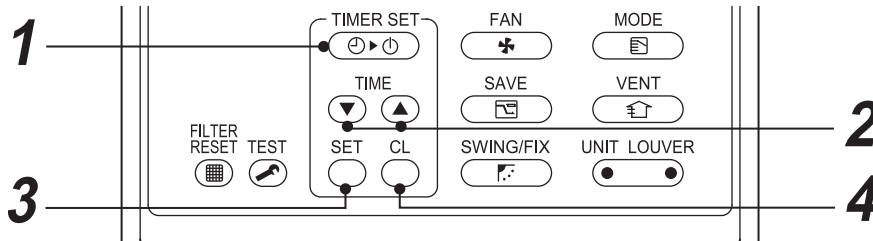

Set

1 Push **TIMER SET** button.

The timer mode changes with every push of the button.

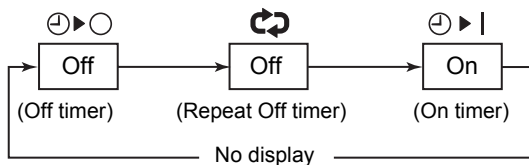

- **SETTING** and timer display flashes.

2 Push **TIME** to select "set time".

- With every push of **▲** button, the set time increases by 0.5 hr (30 minutes).
When setting a time more than 24 hours for timer operation, timer can be set in increments of 1 hr. The maximum set time is 168hr (7 days).
The remote control displays the set time with time (between 0.5 and 23.5 hours) (*1) or number of days and time (24 hours or more) (*2) as shown below.
- With every push of **▼** button, the set time decreases by 0.5 hr (30 minutes) (0.5 - 23.5 hours) or 1 hr (24 - 168 hours).

Example of remote control display

- 23.5 hours (*1)



- 34 hours (*2)



Number of days Time

1d shows 1 day (24 hours).

10h shows 10 hours. (Total 34 hours)

3 Push **SET** button.

- **SETTING** icon disappears and time display goes on, and **▶** or **▶|** icon flashes.
(When On timer is activated, time and On timer **▶|** are icons and other icons disappear.)

4 Cancel timer operation

Push **CL** button.

Timer icon disappears.

NOTE

- When the operation stops after the timer reached the preset time, the Repeat Off timer resumes the operation by pushing **ON/OFF** button and stops the operation after the time of the timer has reached the set time.
- When you push **SWING/FIX** while the Off timer function of the air conditioner is active, the indication of the timer function disappears and then appears again after about 5 seconds.
This is due to normal processing of the remote controller.

6 POWER SAVING MODE

- The power saving mode saves energy by limiting the maximum current which will effect heating or cooling capacity that the unit can generate.

Push  button during operation.

- The air conditioner enters power saving mode.
-  appears on the display.

Power saving mode will stay in effect until it is cancelled.

To cancel the power saving mode, push  button again.

-  disappears.

NOTE

- When other electric appliances are used at the same time, to avoid triggering the circuit breaker, power saving mode is recommended. Of course you can use power saving mode to save energy as well.
- Power saving mode consumes less energy, but may not heat/cool the room as much as normal mode. (The maximum current is limited to approximately 75% (factory default) of the normal mode.)
- To adjust the power-save settings, see "Power saving mode" in ADVANCED SETTINGS.
- Even when operation start/stop, operation mode change, or power reset is performed during the power saving mode, the power saving mode is retained until the next operation.

7 ADVANCED SETTINGS

■ Power saving mode

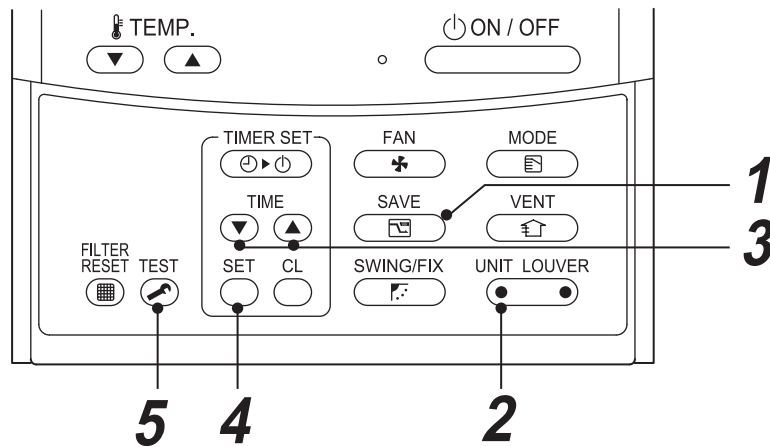

1 Push button for at least four seconds when the air conditioner is not working.

- , symbol, and numbers flash.

2 Push (left side of the button) to select an indoor unit to be set.

- Each time you push the button, UNIT No. change as follows:

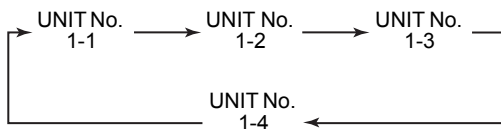

The fan of the selected unit runs.

3 Push TIME buttons, to adjust the power saving mode setting.

- Each push of the button changes the power level by 1% within the range from 100% to 50%.
- The factory default is 75%.

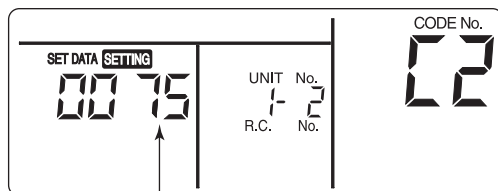

Setting of power level in power saving mode

4 Push button.

5 Push button to complete the setting.

8 ENERGY SAVING RECOMMENDATIONS

Select a comfortable set point and minimize adjusting it.

- Clean the filter when ever the filter display  is illuminated on remote controller.
- Keep doors and windows closed and open them only when necessary.
- Use drapes, curtains, or shades to keep direct sun light from heating the room on very hot days.
- Do not obstruct the return air grille.

Adjust the air flow direction for even air distribution in the room.

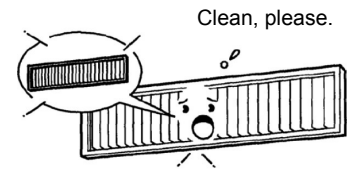

Checks before operating

- Check whether the earth wires are properly connected.
- Check whether the air filters are installed.
- Turn on the leakage breaker at least 12 hours before operating.

Protective device

- The protective device stops operation when the air conditioner is overloaded.
- When the protective device is activated, the current operation stops and the operation lamp and  on the remote controller flash.

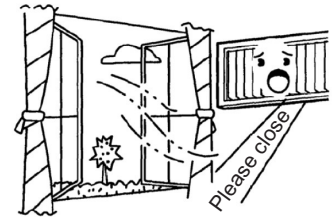

When the protective device is activated

- When the protective device has been activated and stopped operation, turn off the leakage breaker immediately, and ask the installer to find the cause.
If the air conditioner is operated without fixing the problem, the air conditioner may malfunction.
- Check whether the air filters are installed.
If the air filters are not installed, the air heat exchanger may be clogged with dust, which may result in water leakage.

For cooling

- When the air inlet and/or outlet of the outdoor unit are blocked
- When the air outlet of the outdoor unit is continuously exposed to strong wind

For heating

- When the air filters are clogged with too much dust or dirt
- When the suction port and/or discharge port of the indoor unit are blocked

Do not turn off the leakage breaker

- Do not turn off the leakage breaker during a test run of the air conditioner. Use the ON/OFF button on the air conditioner instead to control the power.



9 MAINTENANCE

⚠ WARNING

Cleaning the air filter and other parts of the air filter involves dangerous work in high places, so be sure to have a qualified installer or qualified service person to do it. Do not attempt it by yourself.

Cleaning air filters

Clogged air filters will reduce the cooling and heating performance.

- (1) If “” is displayed on the remote controller, clean the air filters.
- (2) When the cleaning of air filters has been completed, push  button. “” disappears.

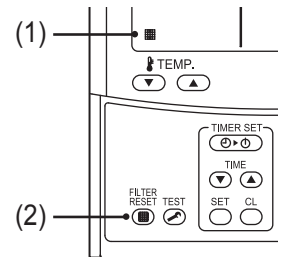

⚠ CAUTION

Cleaning remote controller

- Use a dry cloth to wipe the remote controller.
- Never use a damp cloth on the remote controller.
- Do not use a chemically-treated duster for wiping or leave such materials on the unit for long. It may damage or fade the surface of the unit.
- Do not use benzine, thinner, polishing powder, or similar solvents for cleaning. These may cause the plastic surface to crack or deform.

Periodic check

Long-period use of the air conditioner may cause deterioration or failure of parts due to heat, humidity, dust, and operating conditions, or may cause poor drainage of dehumidified water.

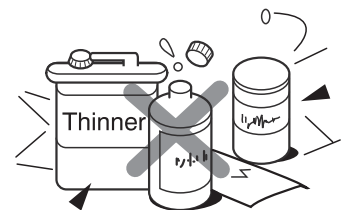

Preparing for long Shut Down Period

- (1) Clean the filters and reposition them in unit.
- (2) Operate the unit in fan mode for 3 or 4 hours to dry all internal parts.
- (3) Turn the unit off and disconnect the main power supply.
- (4) Before unit is turned on again, make sure the circuit breaker has been turned on for at least 12 hours.



Check points before operation

- (1) Check that the air filters are installed.
- (2) Check that the air outlet or inlet is not blocked.
- (3) Turn on the main power switch or the circuit breaker for the main power supply to the air conditioner.

NOTE

For environmental conservation, it is strongly recommended that the indoor and outdoor units of the air conditioner in use be cleaned and maintained regularly to ensure efficient operation of the air conditioner.

When the air conditioner is operated for a long time, periodic maintenance (once a year) is recommended. Furthermore, regularly check the outdoor unit for rust and scratches, and remove them or apply rustproof treatment, if necessary.

As a general rule, when an indoor unit is operated for 8 hours or more daily, clean the indoor unit and outdoor unit at least once every 3 months. Ask a professional for this cleaning/maintenance work.

Such maintenance can extend the life of the product though it involves the owner's expense.

Failure to clean the indoor and outdoor units regularly will result in poor performance, freezing, water leakage, and even compressor failure.

Maintenance List

Part	Unit	Check (visual/auditory)	Maintenance
Heat exchanger	Indoor/outdoor	• Dust/dirt clogging, scratches	• Wash the heat exchanger when it is clogged.
Fan motor	Indoor/outdoor	• Sound	• Take appropriate measures when abnormal sound is generated.
Filter	Indoor	• Dust/dirt, breakage	• Wash the filter with water when it is contaminated. • Replace it when it is damaged.
Fan	Indoor	• Vibration, balance • Dust/dirt, appearance	• Replace the fan when vibration or balance is terrible. • Brush or wash the fan when it is contaminated.
Air inlet/outlet grilles	Indoor/outdoor	• Dust/dirt, scratches	• Fix or replace them when they are deformed or damaged.
Drain pan	Indoor	• Dust/dirt clogging, drain contamination	• Clean the drain pan and check the downward slope for smooth drainage.
Ornamental panel, louvers	Indoor	• Dust/dirt, scratches	• Wash them when they are contaminated or apply repair coating.
Exterior	Outdoor	• Rust, peeling of insulator • Peeling/lift of coat	• Apply repair coating.

10 AIR CONDITIONER OPERATIONS AND PERFORMANCE

3 minutes protection function

3-minutes protection function prevents the air conditioner from starting for initial 3 minutes after the main power switch/circuit breaker is turned on for re-starting the air conditioner.

Power failure

Power failure during operation will stop the unit completely.

- To restart the operation, push the ON/OFF button on the remote controller.
- Lightning or a wireless car telephone operating nearby may cause the unit to malfunction. Turn off the main power switch or circuit breaker and then turn them on again. Push the ON/OFF button on the remote controller to restart.

Heating characteristics

Preheating operation

The air conditioner will not deliver warm air immediately after it is turned on. Warm air will start to flow out after approximately 5 minutes when the indoor heat exchanger warmed up.

Warm air control (In heating operation)

When the room temperature has reached the set temperature while the outdoor unit is stopping, the indoor unit discharges wind with a very small air volume.

Defrosting operation

If the outdoor unit is frosted during the heating operation, defrosting starts automatically (for approximately 2 to 10 minutes) to maintain the heating capacity.

- The fans in both indoor and outdoor units will stop during the defrosting operation.
- During the defrosting operation, the defrosted water will be drained from the bottom plate of the outdoor unit.

Heating capacity

In the heating operation, the heat is absorbed from the outside and brought into the room. This way of heating is called heat pump system. When the outside temperature is too low, it is recommended to use another heating apparatus in combination with the air conditioner.

Attention to snowfall and freeze on the outdoor unit

- In snowy areas, the air inlet and air outlet of the outdoor unit are often covered with snow or frozen up. If snow or freeze on the outdoor unit is left as it is, it may cause machine failure or poor warming.
- In cold areas, pay attention to the drain hose so that it perfectly drains water without water remaining inside for freeze prevention. If water freezes in the drain hose or inside the outdoor unit, it may cause machine failure or poor warming.

Air conditioner operating conditions

For proper performance, operate the air conditioner under the following temperature conditions:

Cooling operation	Outdoor temperature	: -15°C to 46°C
	Room temperature	: 21°C to 32°C (Dry bulb temp.), 15°C to 24°C (Wet bulb temp.)
	[CAUTION]	Room relative humidity – less than 80 %. If the air conditioner operates in excess of this figure, the surface of the air conditioner may cause dewing.
Heating operation	Outdoor temperature	: -20°C to 15°C (Wet bulb temp.)
	Room temperature	: 15°C to 28°C (Dry bulb temp.)

If air conditioner is used outside of the above conditions, safety protection may work.

11 INSTALLATION

Do not install the air conditioner in the following places

- Do not install the air conditioner in any place within 1 m from a TV, stereo, or radio set. If the unit is installed in such place, noise transmitted from the air conditioner affects the operation of these appliances.
- Do not install the air conditioner near a high frequency appliance (sewing machine or massager for business use, etc.), otherwise the air conditioner may malfunction.
- Do not install the air conditioner in a humid or oily place, or in a place where steam, soot, or corrosive gas is generated.
- Do not install the air conditioner in a salty place such as seaside area.
- Do not install the air conditioner in a place where a great deal of machine oil is used.
- Do not install the air conditioner in a place where it is usually exposed to strong wind such as in seaside area.
- Do not install the air conditioner in a place where sulfurous gas generated such as in a spa.
- Do not install the air conditioner in a vessel or mobile crane.
- Do not install the air conditioner in an acidic or alkaline atmosphere (in a hot-spring area or near a chemicals factory, or in a place subject to combustion emissions). Corrosion may be generated on the aluminum fin and copper pipe of the heat exchanger.
- Do not install the air conditioner near an obstacle (air vent, lighting equipment, etc.) that disturbs discharge air. (Turbulent airflow may reduce the performance or disable devices.)
- Do not use the air conditioner for special purposes such as preserving food, precision instruments, or art objects, or where breeding animals or growing plants are kept.
(This may degrade the quality of preserved materials.)
- Do not install the air conditioner over an object that must not get wet. (Condensation may drop from the indoor unit at a humidity of 80% or more or when the drain port is clogged.)
- Do not install the air conditioner in a place where an organic solvent is used.
- Do not install the air conditioner near a door or window subject to humid outside air.
Condensation may form on the air conditioner.
- Do not install the air conditioner in a place where special spray is used frequently.

Be careful with noise or vibrations

- Do not install the air conditioner in a place where noise by outdoor unit or hot air from its air outlet annoys your neighbors.
- Install the air conditioner on a solid and stable foundation so that it prevents transmission of resonating, operation noise and vibration.
- If one indoor unit is operating, some sound may be audible from other indoor units that are not operating.

12 TROUBLESHOOTING

CAUTION

If any of the following conditions occur, turn off the main power supply switch and immediately contact the dealer :

- Switch operation does not work properly.
- The main power fuse often blows out, or the circuit breaker is often activated.
- A foreign matter or water fall inside the air conditioner.
- When the air conditioner does not operate even after the cause of the protective device activation has been removed. (The operation lamp and  on the remote controller are flashing.)
- Any other unusual conditions are observed.

Before you ask for servicing or repairs, check the following points.

▼ Recheck

Inoperative

- The main power switch is turned off.
- The circuit breaker is activated to cut off power supply.
- The main power fuse has blown out.

Does not cool well or heat well

- The air inlet and/or outlet of the outdoor unit is blocked.
- Doors or windows are opened.
- The set temperature is too high (In cooling) or low (In heating).

▼ These are not failures.

Indoor unit or outdoor unit makes a strange noise.

- When the temperature suddenly changes, the indoor or outdoor unit occasionally makes a strange noise because of expansion/ contraction of parts or change of refrigerant flow.
- Air leaking noise is heard occasionally.
It is generated by the solenoid valve when it is actuated.
- A clattering sound is heard when the power is turned on.
It is generated by the outdoor unit during preparation for operation.

The room air is smelly or a bad odor comes from the air conditioner.

- Smells impregnated in the walls, carpets, furniture, clothing, or furs, come out.

Outdoor unit is frosted in heating operation.

Water drains from outdoor unit.

- The outdoor unit is sometimes frosted in heating operation.
In that case, the unit automatically performs defrosting (for 2 to 10 minutes) for increasing the heating efficiency.
- In defrosting operation, both the indoor and outdoor units stop air flow.
- Hiss sound is heard when flow of the refrigerant is changed for defrosting.
- Resultant water of automatic defrosting in heating operation drains from outdoor unit.

A white mist of chilled air or water is generated from the outdoor unit.

- When the indoor unit in cooling operation or the outdoor unit in defrosting operation occasionally steams.

Check these items. If any of these problems still remains, stop the operation, turn off the leakage breaker, and then notifies the dealer of the serial number and details of the error. Never repair any part by yourself as it is dangerous. When  and a combination of **E**, **F**, **H**, **L**, or **P** and a number are displayed on the remote controller, also inform the dealer of the display content.

13 SPECIFICATIONS

Model	Sound power level (dB)		Weight (Kg)
	Cooling	Heating	
RAV-SM2242DT-E	74	74	160
RAV-SM2802DT-E	75	75	160

Declaration of Conformity

Manufacturer: Toshiba Carrier Corporation
336 Tadehara, Fuji-shi, Shizuoka-ken 416-8521 JAPAN

Authorized Representative/
TCF holder: Nick Ball
Toshiba EMEA Engineering Director
Toshiba Carrier UK Ltd.
Porsham Close, Belliver Industrial Estate,
PLYMOUTH, Devon, PL6 7DB.
United Kingdom

Hereby declares that the machinery described below:

Generic Denomination: Air Conditioner

Model/type: RAV-SM2242DT-E,
RAV-SM2802DT-E,
RAV-SM2242DT-TR,
RAV-SM2802DT-TR

Commercial name: Digital Inverter Series Air Conditioner

Complies with the provisions of the "Machinery" Directive (Directive 2006/42/EC) and the regulations transposing into national law

Complies with the provisions of the following harmonized standard:
EN 378-2: 2008

NOTE

This declaration becomes invalid if technical or operational modifications are introduced without the manufacturer's consent.

Information according to EMC Directive 2004/108/EC	
(Name of the manufacturer)	TOSHIBA CARRIER CORPORATION
(Address, city, country)	336 Tadehara, Fuji-shi, Shizuoka-ken 416-8521 Japan
(Name of the Importer/Distributor in EU)	Toshiba Carrier UK Ltd.
(Address, city, country)	Porsham Close, Belliver Industrial Estate, PLYMOUTH, Devon, PL6 7DB. United Kingdom

TOSHIBA CARRIER CORPORATION